



KTM-WP11182P

KTM

CONTRAST SENSORS

SICK
Sensor Intelligence.



Ordering information

Type	Part no.
KTM-WP1182P	1062201

Other models and accessories → www.sick.com/KTM

Illustration may differ



Detailed technical data

Features

Dimensions (W x H x D)	12 mm x 31.5 mm x 21 mm
Sensing distance	≤ 12.5 mm
Sensing distance tolerance	± 3 mm
Housing design	Small
Light source	LED, RGB ¹⁾
Wave length	470 nm, 525 nm, 625 nm
Light emission	Long side of housing
Light spot size	1.6 mm x 9.5 mm
Light spot direction	Vertical ²⁾
Receiving filters	None
Adjustment	Teach-in button
Teach-in mode	2-point teach-in static/dynamic + proximity to mark ET: Teach-in dynamic

¹⁾ Average service life: 100,000 h at T_U = +25 °C.

²⁾ In relation to long side of housing.

Mechanics/electronics

Supply voltage	12 V DC ... 24 V DC ¹⁾
Ripple	≤ 5 V _{pp} ²⁾

¹⁾ Limit values: DC 12 V (-10 %) ... DC 24 V (+20 %). Operation in short-circuit protected network max. 8 A.

²⁾ May not exceed or fall below U_v tolerances.

³⁾ Without load.

⁴⁾ With light/dark ratio 1:1.

⁵⁾ Signal transit time with resistive load.

⁶⁾ Total current of all Outputs.

Current consumption	< 50 mA ³⁾
Switching frequency	15 kHz ⁴⁾
Response time	32 μs ⁵⁾
Jitter	15 μs
Switching output	PNP
Switching output (voltage)	PNP: HIGH = $U_V \leq 2 \text{ V}$ / LOW approx. 0 V
Switching mode	Light/dark switching
Output current I_{max}	50 mA ⁶⁾
Input, dynamic teach-in (ET)	PNP: Teach: $U = 10,8 \text{ V} \dots < U_V$ PNP: Run: $U < 2 \text{ V}$ or open
Retention time (ET)	28 ms, non-volatile memory
Time delay	None
Connection type	Cable with M12 male connector, 4-pin, 0.2 m
Protection class	III
Circuit protection	U_V connections, reverse polarity protected Output Q short-circuit protected Interference pulse suppression
Enclosure rating	IP67
Weight	20 g
Housing material	Plastic, ABS
Optics material	Plastic, PMMA
Indication	LED indicator green: power on LED indicator, yellow: Status switching output Q

¹⁾ Limit values: DC 12 V (-10 %) ... DC 24 V (+20 %). Operation in short-circuit protected network max. 8 A.

²⁾ May not exceed or fall below U_V tolerances.

³⁾ Without load.

⁴⁾ With light/dark ratio 1:1.

⁵⁾ Signal transit time with resistive load.

⁶⁾ Total current of all Outputs.

Ambient data

Ambient operating temperature	-10 °C ... +55 °C
Ambient temperature, storage	-20 °C ... +75 °C
Shock load	According to IEC 60068
UL File No.	NRKH.E348498 & NRKH7.E348498

Classifications

ECLASS 5.0	27270906
ECLASS 5.1.4	27270906
ECLASS 6.0	27270906
ECLASS 6.2	27270906
ECLASS 7.0	27270906
ECLASS 8.0	27270906
ECLASS 8.1	27270906
ECLASS 9.0	27270906

ECLASS 10.0	27270906
ECLASS 11.0	27270906
ECLASS 12.0	27270906
ETIM 5.0	EC001820
ETIM 6.0	EC001820
ETIM 7.0	EC001820
ETIM 8.0	EC001820
UNSPSC 16.0901	39121528

Connection/Pin assignment

Connection type	Cable with M12 male connector, 4-pin, 0.2 m	
Pin assignment	BN 1	+ (L+)
	WH 2	ET
	BU 3	- (M)
	BK 4	Q

Dimensional drawing (Dimensions in mm (inch))

KTM-Mxxxxx2P, KTM-Wxxxxx2P

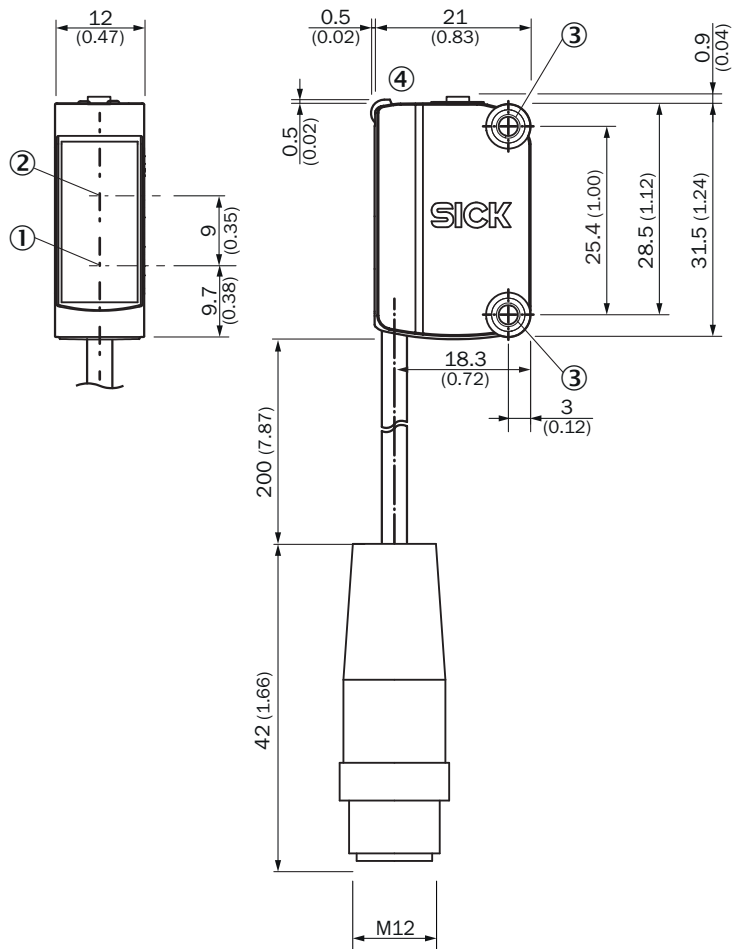

- ① Center of optical axis, sender
- ② Center of optical axis, receiver
- ③ Mounting holes M3
- ④ Display and adjustment elements

Adjustments

Display and adjustment elements

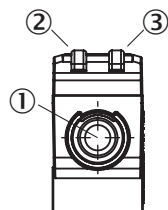

- ① Teach-in button
- ② LED yellow
- ③ LED green

Pin assignment

Connection type. see table: Connection/PIN assignment

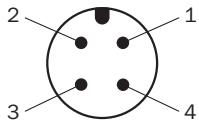

M12 male connector, 4-pin, A-coding

Concept of operation

Setting the switching threshold (dynamic)

1. Position background

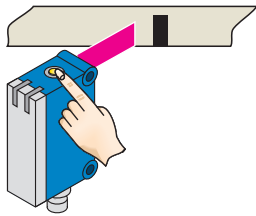

Press the teach-in button and keep it pressed. LED flashing slowly.

2. Move at least the mark and background using the light spot.

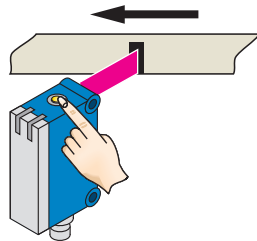

Keep the teach-in button > 3 < 30 s pressed.

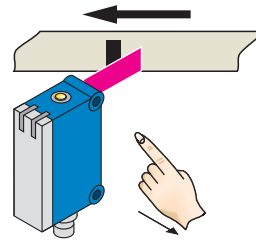

Release the teach-in button.

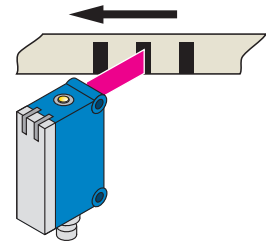

Yellow LED will illuminate, when emitted light is on the mark.

Example

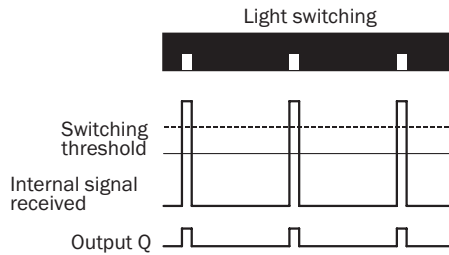
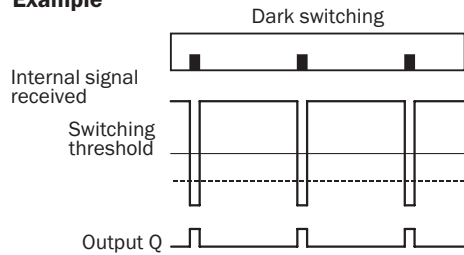

Switching characteristics

The optimum emitted light is selected automatically (at RGB variants).

Static teach-in: light/dark setting is defined using teach-in sequence.

Dynamic teach-in: switching output active on mark, if background is longer in the field of view during the teach-in.

The switching threshold is set in the center between the background and the mark.

If the button is pressed again within 10 s of the teach (> 20 ms < 10 s), the relative switching threshold is placed 75 % between mark (100 %) and background (0 %) (dotted line in Figure).

Teach-in can also be performed using an external control signal.

Keylock activation and deactivation: hold down teach-in button > 30 s.

Teach-in failure: yellow LED indicator and the transmitted light of the sensor flashing quickly.

For dynamic teach-in with ET signal (5 Hz) via switching output Q.

Setting the switching threshold (static)

1. Position mark



Press and hold teach-in button > 1 < 3 s.
Yellow LED flashes slowly.

2. Position background

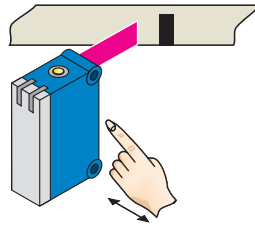

Press and hold teach-in button < 3 s.
Yellow LED goes out.

Sensing distance

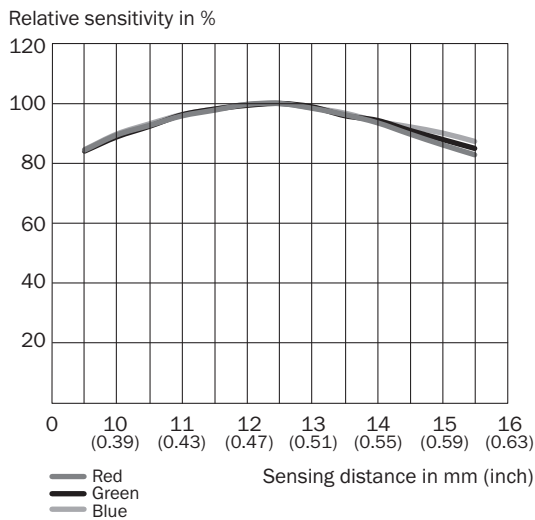

Recommended accessories

Other models and accessories → www.sick.com/KTM

	Brief description	Type	Part no.
Mounting brackets and plates			
	Mounting bracket for wall mounting, stainless steel, mounting hardware included	BEF-W100-A	5311520
Plug connectors and cables			
	<ul style="list-style-type: none"> • Connection type head A: Female connector, M12, 4-pin, straight, A-coded • Connection type head B: Flying leads • Signal type: Sensor/actuator cable • Cable: 5 m, 4-wire, PVC • Description: Sensor/actuator cable, unshielded • Application: Zones with chemicals 	YF2A14-050VB3XLEAX	2096235

	Brief description	Type	Part no.
	<ul style="list-style-type: none"> • Connection type head A: Female connector, M12, 4-pin, straight, A-coded • Connection type head B: Male connector, M12, 4-pin, straight, A-coded • Signal type: Sensor/actuator cable • Cable: 5 m, 4-wire, PVC • Description: Sensor/actuator cable, unshielded • Application: Zones with chemicals 	<p>YF2A14-050VB3M2A14</p>	<p>2096600</p>

SICK AT A GLANCE

SICK is one of the leading manufacturers of intelligent sensors and sensor solutions for industrial applications. A unique range of products and services creates the perfect basis for controlling processes securely and efficiently, protecting individuals from accidents and preventing damage to the environment.

We have extensive experience in a wide range of industries and understand their processes and requirements. With intelligent sensors, we can deliver exactly what our customers need. In application centers in Europe, Asia and North America, system solutions are tested and optimized in accordance with customer specifications. All this makes us a reliable supplier and development partner.

Comprehensive services complete our offering: SICK LifeTime Services provide support throughout the machine life cycle and ensure safety and productivity.

For us, that is “Sensor Intelligence.”

WORLDWIDE PRESENCE:

Contacts and other locations –www.sick.com