



Solenoid Driver

KFD2-SLD-Ex2.1545

- 2-channel isolated barrier
- 24 V DC supply (bus or loop powered)
- Output 45 mA at 15 V DC
- Line fault transparency (LFT)
- Test pulse immunity
- Up to SIL 3 acc. to IEC/EN 61508



Function

This isolated barrier is used for intrinsic safety applications. The device supplies power to solenoids, LEDs and audible alarms located in the explosion-hazardous area. The device is controlled with a loop powered signal or a bus powered logic signal. The device is immune to the test pulses of various control systems. The device simulates a minimum load at the input. The minimum load is set via the mode of operation. In the loop-powered mode of operation, a minimum load of 35 mA is simulated. In the bus-powered mode of operation, a minimum load of 5 mA is simulated. The line fault transparency function can display a line fault in the field by a change in impedance at the switching input of the solenoid driver. A fault is indicated by LEDs and output via a fault indication output.

Connection

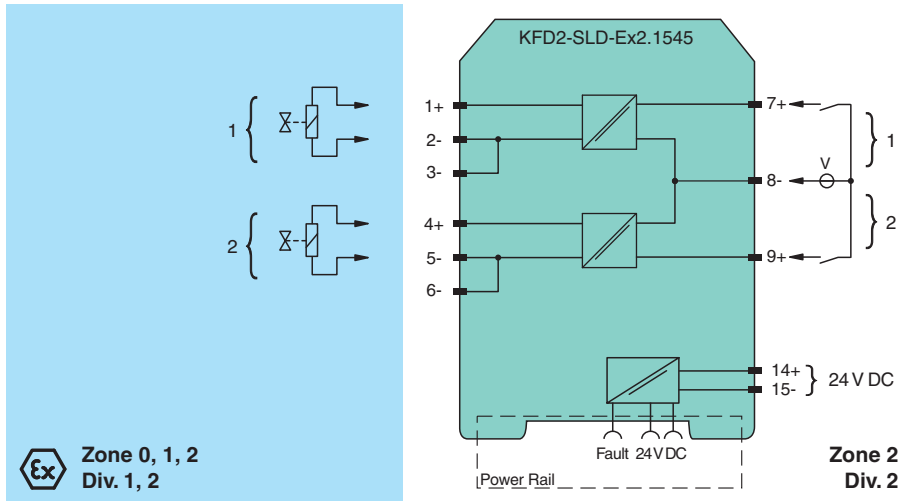

Technical Data

General specifications	
Signal type	Digital Output
Functional safety related parameters	
Safety Integrity Level (SIL)	SIL 3
Systematic capability (SC)	SC 3
Supply	
Connection	Power Rail or terminals 14+, 15-
Rated voltage	U_r 18 ... 30 V DC
Power consumption	max. 3.5 W at 45 mA output current
Input	

Release date: 2023-03-28 Date of issue: 2023-03-28 Filename: 70153577_eng.pdf

Refer to "General Notes Relating to Pepperl+Fuchs Product Information".

Pepperl+Fuchs Group
www.pepperl-fuchs.com

USA: +1 330 486 0002
pa-info@us.pepperl-fuchs.com

Germany: +49 621 776 2222
pa-info@de.pepperl-fuchs.com

Singapore: +65 6779 9091
pa-info@sg.pepperl-fuchs.com

PEPPERL+FUCHS

Technical Data

Connection side		control side
Connection		terminals 7, 8, 9
Test pulse length		max. 2 ms from DO card
Signal level		loop powered 1-signal: 18 ... 30 V DC 0-signal: 0 ... 5 V DC bus powered 1-signal: 15 ... 30 V DC (current limited at 5 mA) 0-signal: 0 ... 5 V DC
Rated current	I_r	0-signal: typ. 1.6 mA at 1.5 V DC; typ. 8 mA at 3 V DC (maximum leakage current DO card) 1-signal: ≥ 35 mA (minimum load current DO card)
Inrush current		≤ 200 mA after 100 μ s
Output		
Connection side		field side
Connection		channel 1: terminals 1+, 2-, 3- channel 2: terminals 4+, 5-, 6-
Internal resistor	R_i	169 Ω
Current	I_e	45 mA
Voltage	U_e	≥ 15 V
Open loop voltage	U_s	min. 23.6 V
Load		nominal 0.05 ... 20 k Ω
Energized/De-energized delay		≤ 20 ms / ≤ 20 ms
Line fault detection		signal at short-circuit $R_{load} < 25 \Omega$, lead breakage $R_{load} > 50$ k Ω ; test current $< 500 \mu$ A
Galvanic isolation		
Input/Output		reinforced insulation according to IEC/EN 61010-1, rated insulation voltage 300 V _{eff}
Power supply/Output		reinforced insulation according to IEC/EN 61010-1, rated insulation voltage 300 V _{eff}
Indicators/settings		
Display elements		LEDs
Control elements		DIP switch
Configuration		via DIP switches
Labeling		space for labeling at the front
Directive conformity		
Electromagnetic compatibility		
Directive 2014/30/EU		EN 61326-1:2013 (industrial locations)
Conformity		
Electromagnetic compatibility		NE 21:2017, EN IEC 61326-1:2021 (industrial locations), EN IEC 61326-3-2:2018 For further information see system description.
Ambient conditions		
Ambient temperature		-40 ... 70 °C (-40 ... 158 °F), both channels configured in the bus powered mode of operation -40 ... 60 °C (-40 ... 140 °F), all other configurations extended ambient temperature range up to 70 °C (158 °F) for other configurations, refer to manual for necessary mounting conditions
Mechanical specifications		
Degree of protection		IP20
Connection		screw terminals
Mass		approx. 150 g
Dimensions		20 x 119 x 115 mm (0.8 x 4.7 x 4.5 inch) (W x H x D), housing type B2
Mounting		on 35 mm DIN mounting rail acc. to EN 60715:2001
Data for application in connection with hazardous areas		
EU-type examination certificate		FIDI 21 ATEX 0091 X
Marking		Ⓜ II 3(1)G Ex ec [ia Ga] IIC T4 Gc Ⓜ II (1)D [Ex ia Da] IIIC Ⓜ I (M1) [Ex ia Ma] I
Output		Ex ia
Voltage	U_o	25.2 V
Current	I_o	52 mA
Power	P_o	850 mW (angular characteristic curve)

Release date: 2023-03-28 Date of issue: 2023-03-28 Filename: 70153577_eng.pdf

Refer to "General Notes Relating to Pepperl+Fuchs Product Information".

Technical Data



Supply			
Maximum safe voltage	U _m	250 V (Attention! The rated voltage can be lower.)	
Input			
Maximum safe voltage	U _m	250 V (Attention! The rated voltage can be lower.)	
Collective error message			
Maximum safe voltage	U _m	250 V (Attention! The rated voltage can be lower.)	
Galvanic isolation			
Input/Output	safe electrical isolation acc. to IEC/EN 60079-11, rated insulation voltage 300 V _{rms}		
Output/power supply	safe electrical isolation acc. to IEC/EN 60079-11, rated insulation voltage 300 V _{rms}		
Directive conformity			
Directive 2014/34/EU	EN IEC 60079-0:2018+AC:2020 , EN 60079-7:2015+A1:2018 , EN 60079-11:2012		
International approvals			
UL approval	E106378		
Control drawing	116-0488		
IECEx approval			
IECEx certificate	IECEx FIDI 21.0009X		
IECEx marking	Ex ec [ia Ga] IIC T4 Gc [Ex ia Da] IIC [Ex ia Ma] I		
General information			
Supplementary information	Observe the certificates, declarations of conformity, instruction manuals, and manuals where applicable. For information see www.pepperl-fuchs.com.		

Assembly

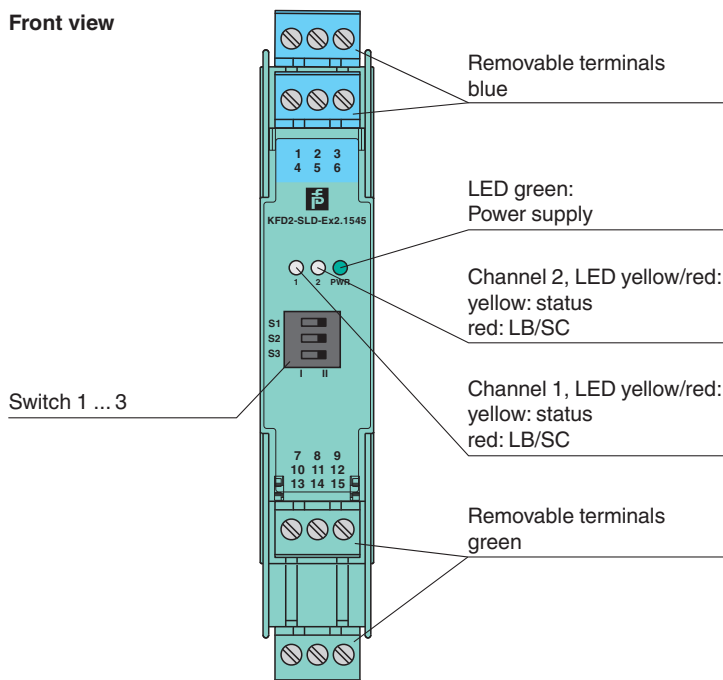
Front view



Matching System Components

	KFD2-EB2	Power Feed Module
	UPR-03	Universal Power Rail with end caps and cover, 3 conductors, length: 2 m

Release date: 2023-03-28 Date of issue: 2023-03-28 Filename: 70153577_eng.pdf

Refer to "General Notes Relating to Pepperl+Fuchs Product Information".

Pepperl+Fuchs Group
www.pepperl-fuchs.com





USA: +1 330 486 0002
pa-info@us.pepperl-fuchs.com

Germany: +49 621 776 2222
pa-info@de.pepperl-fuchs.com



Singapore: +65 6779 9091
pa-info@sg.pepperl-fuchs.com

 **PEPPERL+FUCHS**

Matching System Components

	UPR-03-M	Universal Power Rail with end caps and cover, 3 conductors, length: 1,6 m
	UPR-03-S	Universal Power Rail with end caps and cover, 3 conductors, length: 0.8 m
	K-DUCT-BU	Profile rail, wiring comb field side, blue
	K-DUCT-BU-UPR-03	Profile rail with UPR-03- * insert, 3 conductors, wiring comb field side, blue

Accessories

	KF-ST-5GN	Terminal block for KF modules, 3-pin screw terminal, green
	KF-ST-5BU	Terminal block for KF modules, 3-pin screw terminal, blue
	KF-CP	Red coding pins, packaging unit: 20 x 6

Configuration

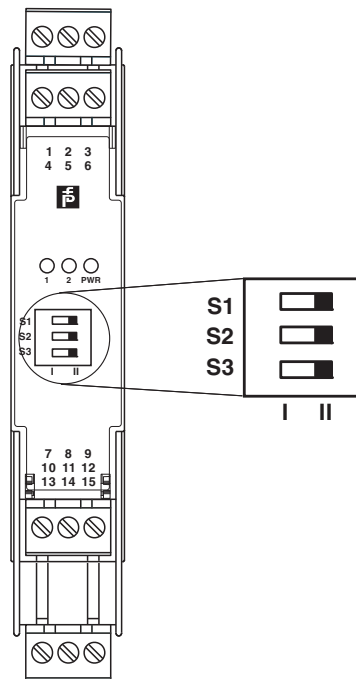

Switch settings

Switch	Function		Position
S1	Line fault detection	enabled	I
		disabled	II
S2	Mode of operation channel 1	loop powered	I
		bus powered	II
S3	Mode of operation channel 2	loop powered	I
		bus powered	II

Factory setting: line fault detection enabled, mode of operation loop powered

Characteristic Curve

Output characteristics

Output circuit diagram

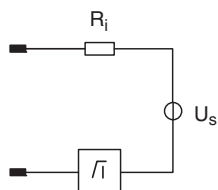

Output characteristic

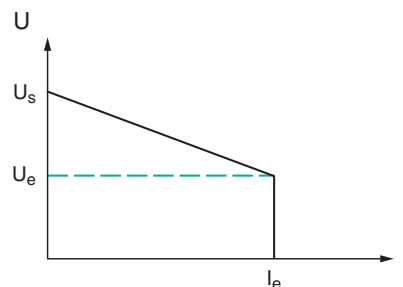

Release date: 2023-03-28 Date of issue: 2023-03-28 Filename: 70153577_eng.pdf