

Relay Module

KFD2-RSH-1.2D.FL2-Y1

- 1-channel signal conditioner
- 24 V DC supply
- Logic input 20.5 V DC ... 26.4 V DC
- Recommended connectable voltage 8 V DC ... 60 V DC
- Relay contact output for de-energized to safe function
- Line fault transparency (LFT)
- Diagnostic function
- Up to SIL 3 acc. to IEC/EN 61508
- Up to PL e acc. to EN/ISO 13849

CE **Ex** **SIL3 PL e**

Function

This signal conditioner provides the galvanic isolation between field circuits and control circuits. The device is a relay module that is suitable for safely switching applications of a load circuit. The device isolates load circuits up to 60 V DC and the 24 V DC control circuit. The de-energized to safe (DTS) function is permitted for SIL 3 and PL e applications. An internal fault or a line fault is signaled by the impedance change of the relay contact input and an additional relay contact output. A fault is signaled by LEDs and a separate collective error message output. The output must be protected against contact welding by an internal fuse or an external current limitation.

Application

This device is compatible to the following control:

- Emerson DeltaV CHARM

Compatibility check to other ESD/DCS systems on request.

Connection

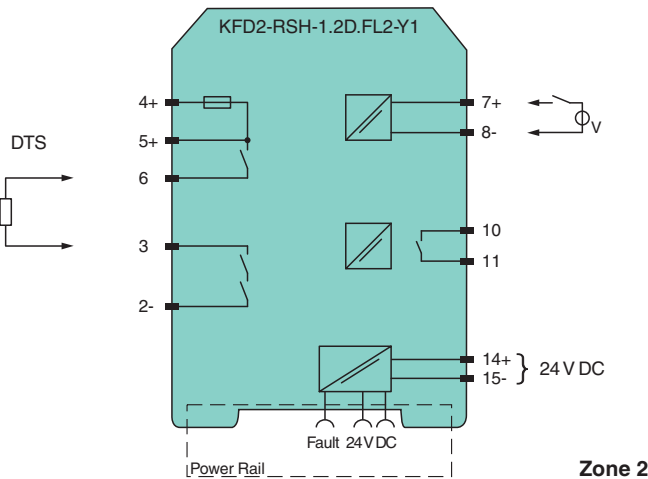

Technical Data

General specifications	
Signal type	Digital Output
Functional safety related parameters	
Safety Integrity Level (SIL)	SIL 3
Systematic capability (SC)	SC 3
Performance level (PL)	PL e

Release date: 2023-03-20 Date of issue: 2023-03-20 Filename: 326595_eng.pdf

Technical Data

Supply		
Connection		Power Rail or terminals 14+, 15-
Rated voltage	U_r	19 ... 26.4 V DC
Input current		max. 35 mA at 24 V DC , max. 44 mA at 19 V DC , with enabled internal fault detection
Power consumption		< 1.7 W , includes the power consumption of the digital input , see derating curves
Input		
Connection side		control side
Connection		terminals 7+, 8-
Pulse/Pause ratio		min. 150 ms / min. 150 ms with disabled internal fault detection min. 1 s / min. 1 s with enabled internal fault detection
Test pulse length		max. 2 ms from DO card
Signal level		0-signal: -5 ... 5 V DC 1-signal: 20.5 ... 26.4 V DC
Rated current	I_r	0-signal: typ. 1.6 mA at 1.5 V DC; typ. 8 mA at 3 V DC (maximum leakage current DO card) 1-signal: ≥ 36 mA (minimum load current DO card)
Inrush current		< 200 mA after 100 μ s
Output		
Connection side		field side
Connection		external voltage : terminals 4+, 5+, 2- load : terminals 6, 3
Connectable voltage		8 ... 60 V DC
Power dissipation		< 3.3 W at 5 A , see derating curves
Contact loading		30 V DC / 5 A resistive load , see derating curves
Minimum switch current		10 mA
Mechanical life		5 x 10 ⁶ switching cycles
Line fault detection		low voltage < 5 V DC undercurrent: 10 mA DC; overcurrent: 2.2 A DC (relay energized) breakage: 8.2 k Ω ; short-circuit: 11 Ω (load, relay de-energized)
Fuse rating		2.5 A (scope of delivery) max. 5 AT, recommended maximum utilization of the fuse: 80 %
Fault indication output		
Connection		terminals 10, 11
Contact loading		30 V DC / 0.5 A resistive load
Reaction time		< 2 s
Mechanical life		10 ⁵ switching cycles
Transfer characteristics		
Switching frequency		< 3 Hz with disabled internal fault detection < 0.5 Hz with enabled internal fault detection
Galvanic isolation		
Input/power supply		basic insulation according to IEC/EN 61010-1, rated insulation voltage 60 V _{eff}
Input/fault indication output		basic insulation according to IEC/EN 61010-1, rated insulation voltage 30 V _{eff}
Output/other circuits		reinforced insulation according to IEC/EN 61010-1, rated insulation voltage 300 V _{eff}
Indicators/settings		
Display elements		LEDs
Control elements		DIP switch
Configuration		via DIP switches
Labeling		space for labeling at the front
Directive conformity		
Electromagnetic compatibility		
Directive 2014/30/EU		EN 61326-1:2013 (industrial locations)
Machinery Directive		
Directive 2006/42/EC		EN 62061:2005+AC:2010+A1:2013+A2:2015 , EN/ISO 13849-1:2015
Conformity		
Electromagnetic compatibility		NE 21:2017 , IEC/EN 61326-3-2:2018 , EN 61326-3-1:2017
Degree of protection		IEC 60529:2013

Release date: 2023-03-20 Date of issue: 2023-03-20 Filename: 326595_eng.pdf

Technical Data

Protection against electrical shock	EN 61010-1:2010
Ambient conditions	
Ambient temperature	-20 ... 60 °C (-4 ... 140 °F) Observe the temperature range limited by derating, see section derating.
Mechanical specifications	
Degree of protection	IP20
Connection	screw terminals
Mass	approx. 142 g
Dimensions	20 x 119 x 115 mm (0.8 x 4.7 x 4.5 inch) (W x H x D) , housing type B2
Mounting	on 35 mm DIN mounting rail acc. to EN 60715:2001
Data for application in connection with hazardous areas	
Certificate	PF 17 CERT 4305 X
Marking	Ⓜ II 3G Ex nC ec IIC T4 Gc [device in zone 2]
Directive conformity	
Directive 2014/34/EU	EN 60079-0:2012+A11:2013 , EN 60079-7:2015 , EN 60079-15:2010
General information	
Supplementary information	Observe the certificates, declarations of conformity, instruction manuals, and manuals where applicable. For information see www.pepperl-fuchs.com .

Assembly

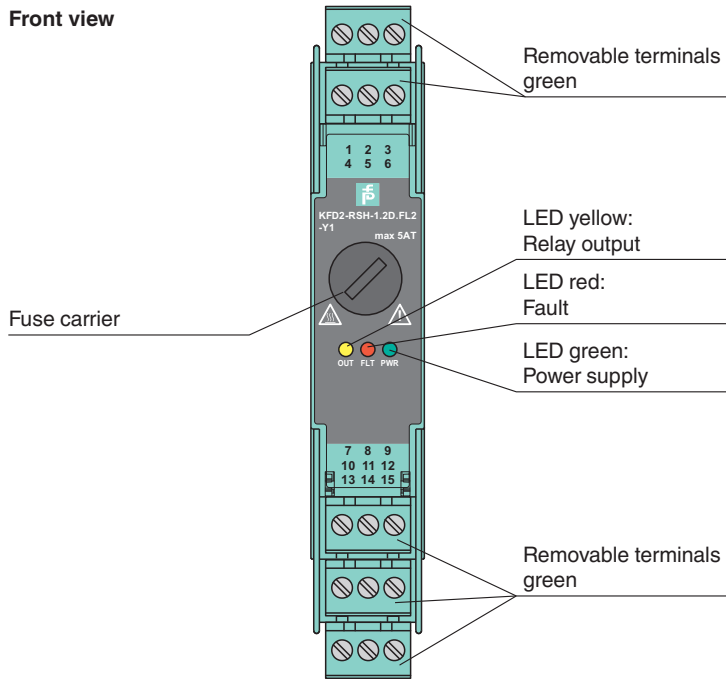



Matching System Components

	KFD2-EB2	Power Feed Module
	UPR-03	Universal Power Rail with end caps and cover, 3 conductors, length: 2 m
	UPR-03-M	Universal Power Rail with end caps and cover, 3 conductors, length: 1,6 m



Release date: 2023-03-20 Date of issue: 2023-03-20 Filename: 326595_eng.pdf

Refer to "General Notes Relating to Pepperl+Fuchs Product Information".

Matching System Components

	UPR-03-S	Universal Power Rail with end caps and cover, 3 conductors, length: 0.8 m
	K-DUCT-GY	Profile rail, wiring comb field side, gray
	K-DUCT-GY-UPR-03	Profile rail with UPR-03-* insert, 3 conductors, wiring comb field side, gray

Accessories

	KF-ST-5GN	Terminal block for KF modules, 3-pin screw terminal, green
	KF-CP	Red coding pins, packaging unit: 20 x 6

Configuration

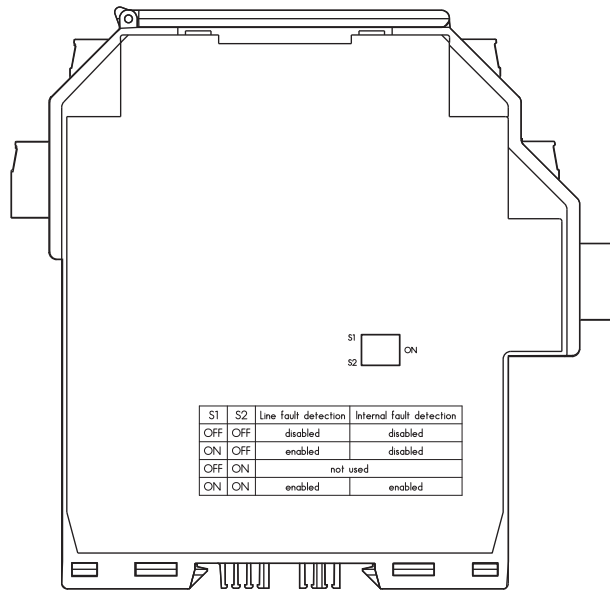

Output switch settings

S1	S2	Line fault detection	Internal fault detection
OFF	OFF	disabled	disabled
ON	OFF	enabled	disabled
OFF	ON	not used	
ON	ON	enabled	enabled

Factory settings: line fault detection enabled, internal fault detection enabled

During a switching event the device detects an internal fault. A full test of all 3 redundant relay channels requires 3 consecutive switching events.

Characteristic Curve

Derating

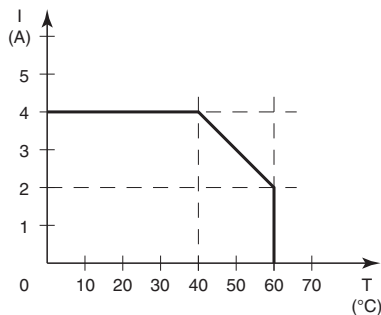

— fused, non-hazardous area
 U_i 26.4 V

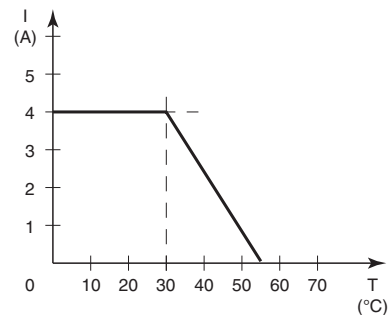

— fused, Zone 2
 U_i 26.4 V

Release date: 2023-03-20 Date of issue: 2023-03-20 Filename: 326595_eng.pdf

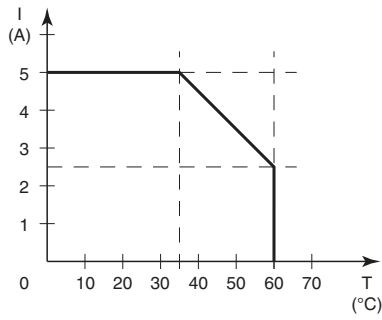

— unfused, non-hazardous area
 U_i 26.4 V

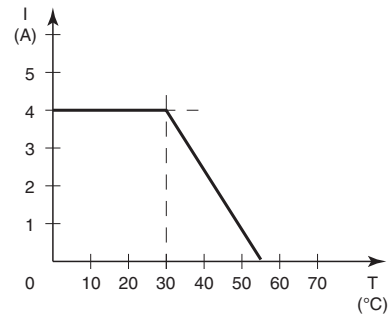

— unfused, Zone 2
 U_i 26.4 V

Characteristic Curve

Maximum Switching Power of Output Contacts

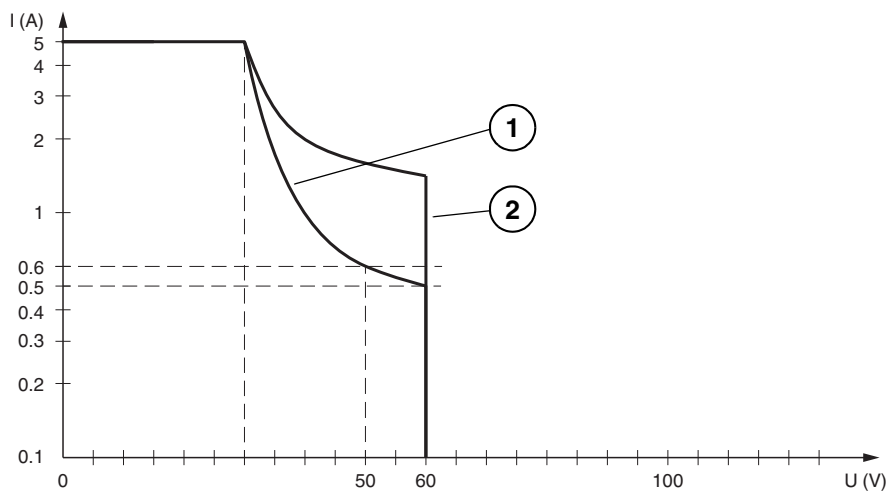

— Resistive load DC
1 max. 10^5 switching cycles
2 max. 3×10^4 switching cycles

The maximum number of switching cycles is depending on the electrical load and may be higher if reduced currents and voltages are applied.