

SMART Transmitter Power Supply, Output Current Sink

KFD2-STC4-Ex1.20-Y1

- 1-channel isolated barrier
- 24 V DC supply (Power Rail)
- Input 2-wire and 3-wire SMART transmitters and 2-wire SMART current sources
- Signal splitter (1 input and 2 outputs)
- Dual output 0/4 mA ... 20 mA, current sink
- Terminal blocks with test sockets
- Up to SIL 3 acc. to IEC/EN 61508



Function

This isolated barrier is used for intrinsic safety applications. The device supplies 2-wire and 3-wire SMART transmitters in a hazardous area, and can also be used with 2-wire SMART current sources. It transfers the analog input signal to the safe area as two isolated current values. Digital signals may be superimposed on the input signal in the hazardous or safe area and are transferred bi-directionally. It is designed to provide a sink mode output on the safe area terminals. If the HART communication resistance in the loop is too low, the internal resistance of 250 Ω between terminals 8 and 9 can be used. Test sockets for the connection of HART communicators are integrated into the terminals of the device.

Connection

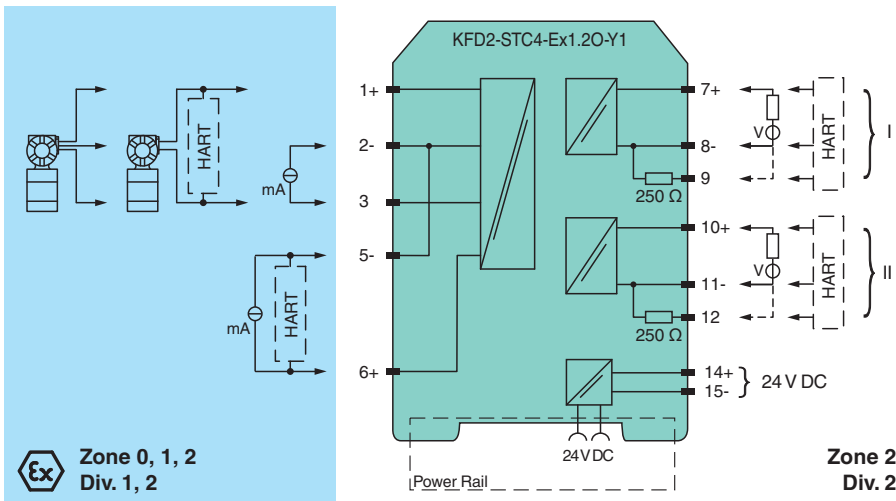

Technical Data

General specifications

Signal type Analog input

Functional safety related parameters

Safety Integrity Level (SIL) SIL 3

Supply

Connection Power Rail or terminals 14+, 15-

Rated voltage U_r 20 ... 35 V DC

Ripple within the supply tolerance

Power dissipation 1.8 W

Power consumption 2.4 W

Release date: 2021-12-20 Date of issue: 2021-12-20 Filename: 283687_eng.pdf

Refer to "General Notes Relating to Pepperl+Fuchs Product Information".

Pepperl+Fuchs Group
www.pepperl-fuchs.com

USA: +1 330 486 0002
pa-info@us.pepperl-fuchs.com

Germany: +49 621 776 2222
pa-info@de.pepperl-fuchs.com

Singapore: +65 6779 9091
pa-info@sg.pepperl-fuchs.com

PF PEPPERL+FUCHS

Technical Data

Input	
Connection side	field side
Connection	terminals 1+, 2-, 3 or 5-, 6+
Input signal	0/4 ... 20 mA
Open circuit voltage/short-circuit current	terminals 1+, 3-: 22.7 V / 38 mA
Voltage drop	terminals 5, 6 : ≤ 2.4 V at 20 mA
Input resistance	terminals 2-, 3: max. 76 Ω terminals 1+, 3: max. 500 Ω (250 Ω load)
Available voltage	terminals 1+, 3: ≥ 16 V at 20 mA
Output	
Connection side	control side
Connection	terminals 7+, 8-; 10+, 11-
Output signal	0/4 ... 20 mA (overload > 25 mA)
Ripple	max. 50 μA_{rms}
External supply (loop)	11 ... 30 V DC
Transfer characteristics	
Deviation	at 20 °C (68 °F), 0/4 ... 20 mA ≤ 10 μA incl. calibration, linearity, hysteresis, loads and fluctuations of supply voltage
Influence of ambient temperature	0.25 $\mu\text{A/K}$
Frequency range	field side into the control side: bandwidth with 0.5 V_{pp} signal 0 ... 7.5 kHz (-3 dB) control side into the field side: bandwidth with 0.5 V_{pp} signal 0.3 ... 7.5 kHz (-3 dB)
Settling time	200 μs
Rise time/fall time	20 μs
Galvanic isolation	
Output/power supply	functional insulation, rated insulation voltage 50 V AC
Output/Output	functional insulation, rated insulation voltage 50 V AC
Indicators/settings	
Display elements	LED
Labeling	space for labeling at the front
Directive conformity	
Electromagnetic compatibility	
Directive 2014/30/EU	EN 61326-1:2013 (industrial locations)
Conformity	
Electromagnetic compatibility	NE 21:2011
Degree of protection	IEC 60529:2001
Protection against electrical shock	UL 61010-1:2012
Ambient conditions	
Ambient temperature	-20 ... 60 °C (-4 ... 140 °F)
Mechanical specifications	
Degree of protection	IP20
Connection	screw terminals
Mass	approx. 200 g
Dimensions	20 x 124 x 115 mm (0.8 x 4.9 x 4.5 inch) , (W x H x D) housing type B2
Mounting	on 35 mm DIN mounting rail acc. to EN 60715:2001
Data for application in connection with hazardous areas	
EU-type examination certificate	BAS 99 ATEX 7060 X
Marking	Ⓜ II (1)G [Ex ia Ga] IIC , Ⓜ II (1)D [Ex ia Da] IIIC , Ⓜ I (M1) [Ex ia Ma] I
Input	[Ex ia Ga] IIC, [Ex ia Da] IIIC, [Ex ia Ma] I
Supply	
Maximum safe voltage	U_m 250 V (Attention! The rated voltage can be lower.)
Equipment	terminals 1+, 3-
Voltage U_o	25.4 V
Current I_o	86.8 mA
Power P_o	551 mW

Release date: 2021-12-20 Date of issue: 2021-12-20 Filename: 283687_eng.pdf

Refer to "General Notes Relating to Pepperl+Fuchs Product Information".

Pepperl+Fuchs Group
www.pepperl-fuchs.comUSA: +1 330 486 0002
pa-info@us.pepperl-fuchs.comGermany: +49 621 776 2222
pa-info@de.pepperl-fuchs.comSingapore: +65 6779 9091
pa-info@sg.pepperl-fuchs.com

PEPPERL+FUCHS

Technical Data

Internal capacitance C_i	12 nF
Internal inductance L_i	0 mH
Equipment	terminals 2-, 3
Current I_i	115 mA
Voltage U_o	3.5 V
Current I_o	74 mA
Power P_o	64 mW
Equipment	terminals 1+, 2 / 3-
Voltage U_i	30 V
Current I_i	115 mA
Voltage U_o	25.4 V
Current I_o	115 mA
Power P_o	584 mW
Equipment	terminals 5-, 6+
Voltage U_i	30 V
Current I_i	115 mA
Voltage U_o	8.7 V
Current I_o	0 mA
Certificate	TÜV 99 ATEX 1499 X
Marking	Ⓜ II 3G Ex nA II T4 [device in zone 2]
Galvanic isolation	
Input/Output	safe electrical isolation acc. to IEC/EN 60079-11, voltage peak value 375 V
Input/power supply	safe electrical isolation acc. to IEC/EN 60079-11, voltage peak value 375 V
Directive conformity	
Directive 2014/34/EU	EN 60079-0:2012+A11:2013 , EN 60079-11:2012 , EN 60079-15:2010
International approvals	
UL approval	
Control drawing	116-0428 (cULus)
IECEx approval	
IECEx certificate	IECEx BAS 04.0016X IECEx CML 15.0055X
IECEx marking	[Ex ia Ga] IIC , [Ex ia Da] IIIC , [Ex ia Ma] I Ex nA IIC T4 Gc
General information	
Note	Both output loads must be connected to ensure complete and correct operation within the technical specification.
Supplementary information	Observe the certificates, declarations of conformity, instruction manuals, and manuals where applicable. For information see www.pepperl-fuchs.com .

Release date: 2021-12-20 Date of issue: 2021-12-20 Filename: 283687_eng.pdf

Refer to "General Notes Relating to Pepperl+Fuchs Product Information".

Pepperl+Fuchs Group
www.pepperl-fuchs.com

USA: +1 330 486 0002
pa-info@us.pepperl-fuchs.com

Germany: +49 621 776 2222
pa-info@de.pepperl-fuchs.com

Singapore: +65 6779 9091
pa-info@sg.pepperl-fuchs.com





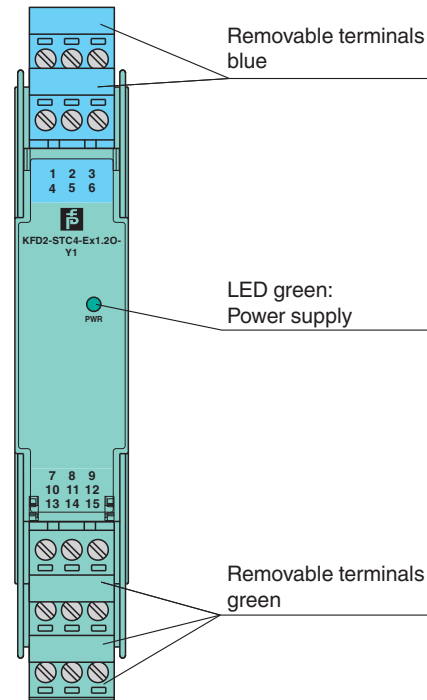

 **PEPPERL+FUCHS**

Assembly





Front view



Matching System Components

	KFD2-EB2	Power Feed Module
	UPR-03	Universal Power Rail with end caps and cover, 3 conductors, length: 2 m
	UPR-03-M	Universal Power Rail with end caps and cover, 3 conductors, length: 1,6 m
	UPR-03-S	Universal Power Rail with end caps and cover, 3 conductors, length: 0.8 m
	K-DUCT-BU	Profile rail, wiring comb field side, blue
	K-DUCT-BU-UPR-03	Profile rail with UPR-03- * insert, 3 conductors, wiring comb field side, blue

Accessories

	KF-STP-5BU	Terminal block for KF modules, 3-pin screw terminal, with test sockets, blue
	KF-STP-5GN	Terminal block for KF modules, 3-pin screw terminal, with test sockets, green
	KF-ST-5GN	Terminal block for KF modules, 3-pin screw terminal, green
	KF-CP	Red coding pins, packaging unit: 20 x 6

Release date: 2021-12-20 Date of issue: 2021-12-20 Filename: 283667_eng.pdf

Refer to "General Notes Relating to Pepperl+Fuchs Product Information".

Pepperl+Fuchs Group
www.pepperl-fuchs.comUSA: +1 330 486 0002
pa-info@us.pepperl-fuchs.comGermany: +49 621 776 2222
pa-info@de.pepperl-fuchs.comSingapore: +65 6779 9091
pa-info@sg.pepperl-fuchs.com
 **PEPPERL+FUCHS**

Application

The device supports the following SMART protocols:

- HART
- BRAIN
- Foxboro

Configuration

Configuration passive output (sink)

If only one output of the two outputs is used, a jumper have to be set as follows.

