



# HART Loop Converter KFD2-HLC-Ex1.D.4S

- 1-channel isolated barrier
- 24 V DC supply (Power Rail)
- HART field device input with transmitter power supply
- Usable as signal splitter (1 input and several outputs)
- 4 relay contact outputs (NO contact)
- 3 analog outputs 4 mA ... 20 mA
- Sink and source mode output
- Configurable by keypad



## Function

This isolated barrier is used for intrinsic safety applications. It is a HART loop converter that provides power to transmitters or can be connected to existing HART loops in parallel. It is able to evaluate up to four HART variables (PV, SV, TV, QV). Of those four HART variables, the data contained in any three of them can be converted to three different 4 mA ... 20 mA current signals. These loop signals can be connected to display devices or analog inputs on the process control system/ control system. In addition to the current outputs, four form A normally open relay contacts are available and can be programmed to operate at trip values from the HART variables. The unit is easily programmed by the use of a keypad located on the front of the unit or with the PACTware™ configuration software. For additional information, refer to the manual and [www.pepperl-fuchs.com](http://www.pepperl-fuchs.com).

## Connection

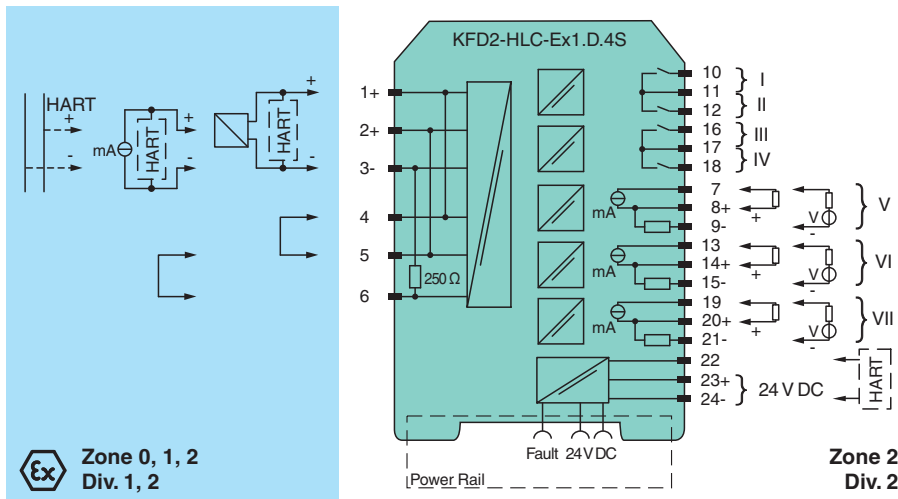

## Technical Data

General specifications	
Signal type	Analog input
<b>Supply</b>	
Connection	Power Rail or terminals 23+, 24-
Rated voltage	$U_r$ 19 ... 30 V DC
Rated current	$I_r$ approx. 140 mA at 24 V DC
Power dissipation	2.7 W
Power consumption	3.3 W
<b>HART signal channels (intrinsically safe)</b>	

Release date: 2023-04-06 Date of issue: 2023-04-06 Filename: 261919\_eng.pdf

Refer to "General Notes Relating to Pepperl+Fuchs Product Information".

Pepperl+Fuchs Group  
[www.pepperl-fuchs.com](http://www.pepperl-fuchs.com)

USA: +1 330 486 0002  
pa-info@us.pepperl-fuchs.com

Germany: +49 621 776 2222  
pa-info@de.pepperl-fuchs.com

Singapore: +65 6779 9091  
pa-info@sg.pepperl-fuchs.com



## Technical Data

Conformity	HART field device input (revision 5 to 7)
<b>Interface</b>	
Programming interface	programming socket
<b>Input</b>	
Connection side	field side
Connection	terminals 1, 2, 3, 4, 5, 6
Open circuit voltage/short-circuit current	typ. 24 V / 28 mA
Input resistance	250 Ω , 5 % (terminals 2, 3 and with jumper on 5, 6)
Available voltage	≥ 15.5 V at 20 mA, short-circuit protected
<b>Output</b>	
Connection side	control side
Connection	output I: terminals 10, 11, output II: terminals 11, 12, output III: terminals 16, 17, output IV: terminals 17, 18 output V: terminals 7, 8, 9, output VI: terminals 13, 14, 15, output VII: terminals 19, 20, 21
Output I, II, III, IV	
Output signal	relay and LED yellow
Mechanical life	10 <sup>7</sup> switching cycles
Energized/De-energized delay	approx. 20 ms / approx. 20 ms
Output V, VI, VII	
Output signal	analog
Current range	4 ... 20 mA , (source or sink mode)
Load	max. 650 Ω , source mode
Voltage range	5 ... 30 V , sink mode from external supply
Fault signal	downscale I ≤ 2 mA, upscale I ≥ 21.5 mA (acc. NAMUR NE43) or hold measurement value
Other outputs	HART communicator on terminals 22, 24
Collective error message	Power Rail and LED red
<b>Transfer characteristics</b>	
Output V, VI, VII	
Resolution	max. 2 μA
Accuracy	< 20 μA, 10 μA typ.
Influence of ambient temperature	< ± 2 μA/K
Duration of measurement/Response delay	HART message acquisition time plus 100 ms
Relay	programmable either for fault or trip value (with direction, hysteresis and delay)
<b>Galvanic isolation</b>	
Output I, II/III, IV	functional insulation acc. to IEC 62103, rated insulation voltage 250 V <sub>eff</sub>
Output I, II, III, IV/other circuits	reinforced insulation acc. to IEC 62103, rated insulation voltage 300 V <sub>rms</sub>
Output V/VI/VII/power supply	functional insulation acc. to IEC 62103, rated insulation voltage 50 V <sub>eff</sub>
<b>Indicators/settings</b>	
Display elements	LEDs , display
Control elements	Control panel
Configuration	via operating buttons via PACTware
Labeling	space for labeling at the front
<b>Directive conformity</b>	
Electromagnetic compatibility	
Directive 2014/30/EU	EN 61326-1:2013 (industrial locations)
Low voltage	
Directive 2014/35/EU	EN 61010-1:2010
<b>Conformity</b>	
Electromagnetic compatibility	NE 21:2006
Degree of protection	IEC 60529:2001
<b>Ambient conditions</b>	
Ambient temperature	-20 ... 60 °C (-4 ... 140 °F)

Release date: 2023-04-06 Date of issue: 2023-04-06 Filename: 261919\_eng.pdf

Refer to "General Notes Relating to Pepperl+Fuchs Product Information".

 Pepperl+Fuchs Group  
www.pepperl-fuchs.com

 USA: +1 330 486 0002  
pa-info@us.pepperl-fuchs.com

 Germany: +49 621 776 2222  
pa-info@de.pepperl-fuchs.com

 Singapore: +65 6779 9091  
pa-info@sg.pepperl-fuchs.com

 **PEPPERL+FUCHS**

## Technical Data

Mechanical specifications		
Degree of protection		IP20
Connection		screw terminals
Mass		300 g
Dimensions		40 x 119 x 115 mm (1.6 x 4.7 x 4.5 inch) (W x H x D) , housing type C2
Mounting		on 35 mm DIN mounting rail acc. to EN 60715:2001
Data for application in connection with hazardous areas		
EU-type examination certificate		BASEEFA 07 ATEX 0174
Marking		Ⓜ II (1)G [Ex ia Ga] IIC Ⓜ II (1)D [Ex ia Da] IIIC
Supply		
Maximum safe voltage	$U_m$	253 V AC (Attention! The rated voltage can be lower.)
Equipment		terminals 1, 4/3 (with link between terminals 4 and 5)
Voltage	$U_o$	25.2 V
Current	$I_o$	104.9 mA
Power	$P_o$	0.661 W
Internal capacitance	$C_i$	1.1 nF
Internal inductance	$L_i$	0 mH
Equipment		terminals 2, 5/3
Voltage	$U_i$	< 28 V
Power	$P_i$	< 1.33 W
Voltage	$U_o$	1.1 V
Current	$I_o$	11.9 mA
Power	$P_o$	4 mW
Internal capacitance	$C_i$	0 $\mu$ F
Internal inductance	$L_i$	0 mH
Output I, II, III, IV		terminals 10, 11; 11, 12; 16, 17; 17, 18 , non-intrinsically safe
Maximum safe voltage	$U_m$	253 V (Attention! $U_m$ is no rated voltage.)
Contact loading		253 V AC/1 A/cos $\phi$ > 0.7; 30 V DC/1 A resistive load (BASEEFA 07 ATEX 0174) 50 V AC/1 A/cos $\phi$ > 0.7; 30 V DC/1 A resistive load (Pepperl+Fuchs self-declaration)
Output V, VI, VII		terminals 7, 8, 9; 13, 14, 15; 19, 20, 21 , non-intrinsically safe
Maximum safe voltage	$U_m$	253 V (Attention! $U_m$ is no rated voltage.)
Certificate		PF 07 CERT 1141 X
Marking		Ⓜ II 3G Ex nA nC IIC T4 Gc
Galvanic isolation		
Input/Other circuits		safe electrical isolation acc. to IEC/EN 60079-11, voltage peak value 375 V
Directive conformity		
Directive 2014/34/EU		EN IEC 60079-0:2018+AC:2020 , EN 60079-11:2012 , EN 60079-15:2010
International approvals		
FM approval		
Control drawing		116-0129
IECEX approval		
IECEX certificate		IECEX BAS 07.0047
IECEX marking		[Ex ia Ga] IIC , [Ex ia Da] IIIC
General information		
Supplementary information		Observe the certificates, declarations of conformity, instruction manuals, and manuals where applicable. For information see <a href="http://www.pepperl-fuchs.com">www.pepperl-fuchs.com</a> .

Release date: 2023-04-06 Date of issue: 2023-04-06 Filename: 261919\_eng.pdf

Refer to "General Notes Relating to Pepperl+Fuchs Product Information".







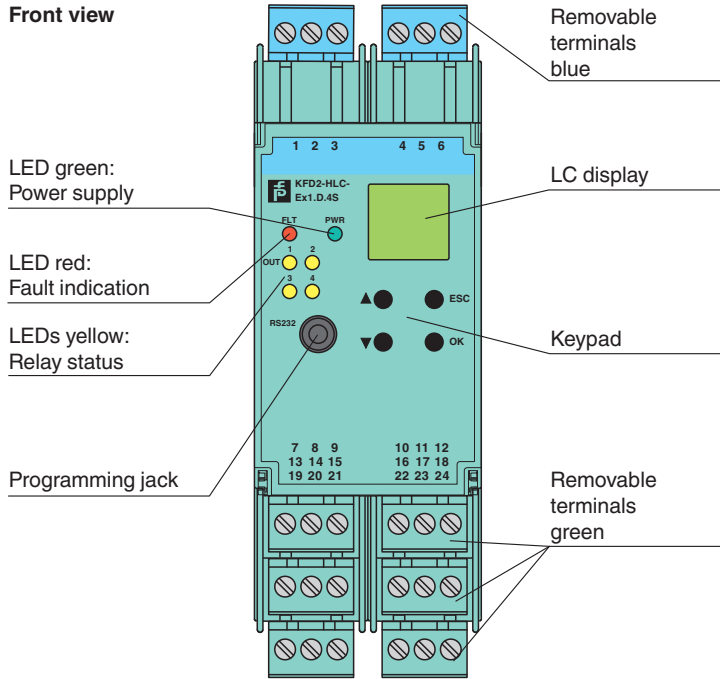

Pepperl+Fuchs Group  
[www.pepperl-fuchs.com](http://www.pepperl-fuchs.com)USA: +1 330 486 0002  
pa-info@us.pepperl-fuchs.comGermany: +49 621 776 2222  
pa-info@de.pepperl-fuchs.comSingapore: +65 6779 9091  
pa-info@sg.pepperl-fuchs.com

**PEPPERL+FUCHS**



**Assembly**



**Matching System Components**

	<b>DTM HART Loop converter</b>	Device type manager (DTM) for HART communication
	<b>PACTware 5.0</b>	FDT Framework
	<b>KFD2-EB2</b>	Power Feed Module
	<b>UPR-03</b>	Universal Power Rail with end caps and cover, 3 conductors, length: 2 m
	<b>UPR-03-M</b>	Universal Power Rail with end caps and cover, 3 conductors, length: 1,6 m
	<b>UPR-03-S</b>	Universal Power Rail with end caps and cover, 3 conductors, length: 0.8 m
	<b>K-DUCT-BU</b>	Profile rail, wiring comb field side, blue
	<b>K-DUCT-BU-UPR-03</b>	Profile rail with UPR-03- * insert, 3 conductors, wiring comb field side, blue



**Accessories**

	<b>K-250R</b>	Measuring resistor
	<b>K-500R0%1</b>	Measuring resistor

Release date: 2023-04-06 Date of issue: 2023-04-06 Filename: 261919\_eng.pdf

Refer to "General Notes Relating to Pepperl+Fuchs Product Information".

**Accessories**

	<b>KF-ST-5GN</b>	Terminal block for KF modules, 3-pin screw terminal, green
	<b>KF-ST-5BU</b>	Terminal block for KF modules, 3-pin screw terminal, blue
	<b>KF-CP</b>	Red coding pins, packaging unit: 20 x 6

## Application

- Configurable as primary or secondary master
- Automatic HART burst supported
- Support for a HART handheld device connected on safe area side
- Can be configured to assign the same input variable to multiple outputs (signal splitting)