



Universal Temperature Converter

KFD2-UT2-Ex1-1

- 1-channel isolated barrier
- 24 V DC supply (Power Rail)
- Thermocouple, RTD, potentiometer or voltage input
- Voltage output 0/1 V ... 5 V
- Configurable by PACTware
- Line fault (LFD) and sensor burnout detection
- Up to SIL 2 acc. to IEC/EN 61508 / IEC/EN 61511



Function

This isolated barrier is used for intrinsic safety applications. The device converts the signal of a resistance thermometer, thermocouple, or potentiometer to a proportional output voltage. The removable terminal block K-CJC-** is available as an accessory for internal cold junction compensation of thermocouples. A fault is signalized by LEDs and a separate collective error message output. The device is easily configured by the use of the PACTware configuration software. For additional information, refer to the manual and www.pepperl-fuchs.com.

Connection

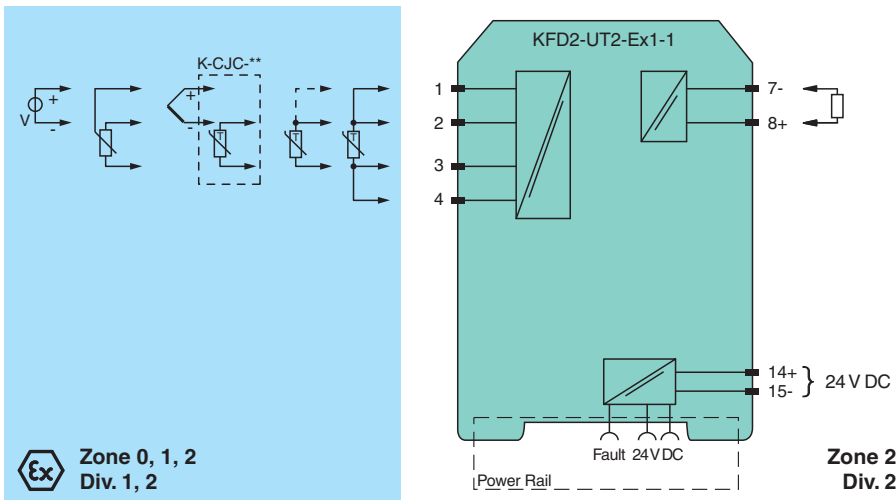

Technical Data

General specifications	
Signal type	Analog input
Functional safety related parameters	
Safety Integrity Level (SIL)	SIL 2
Supply	
Connection	terminals 14+, 15- or power feed module/Power Rail
Rated voltage	U_r 20 ... 30 V DC
Ripple	within the supply tolerance
Power dissipation	≤ 0.64 W
Power consumption	max. 0.64 W
Interface	

Release date: 2023-01-03 Date of issue: 2023-01-03 Filename: 248765_eng.pdf

Refer to "General Notes Relating to Pepperl+Fuchs Product Information".

Pepperl+Fuchs Group
www.pepperl-fuchs.com

USA: +1 330 486 0002
pa-info@us.pepperl-fuchs.com

Germany: +49 621 776 2222
pa-info@de.pepperl-fuchs.com

Singapore: +65 6779 9091
pa-info@sg.pepperl-fuchs.com

PEPPERL+FUCHS

Technical Data

Programming interface	programming socket
Input	
Connection side	field side
Connection	terminals 1, 2, 3, 4
RTD	type Pt10, Pt50, Pt100, Pt500, Pt1000 (EN 60751: 1995) type Pt10GOST, Pt50GOST, Pt100GOST, Pt500GOST, Pt1000GOST (6651-94) type Cu10, Cu50, Cu100 (P50353-92) type Ni100 (DIN 43760)
Measuring current	approx. 200 µA with RTD
Types of measuring	2-, 3-, 4-wire connection
Lead resistance	max. 50 Ω per line
Measurement loop monitoring	sensor breakage, sensor short-circuit
Thermocouples	type B, E, J, K, N, R, S, T (IEC 584-1: 1995) type L (DIN 43710: 1985) type TXK, TXKH, TXA (P8.585-2001)
Cold junction compensation	external and internal
Measurement loop monitoring	sensor breakage
Potentiometer	0 ... 20 kΩ (2-wire connection), 0.8 ... 20 kΩ (3-wire connection)
Voltage	selectable within the range -100 ... 100 mV
Input resistance	≥ 1 MΩ (-100 ... 100 mV)
Output	
Connection side	control side
Voltage output	0 ... 5 V or 1 ... 5 V ; output resistance: ≤ 5 Ω ; load: ≥ 10 kΩ
Connection	terminals 7-, 8+
Fault signal	downscale 0 V or 0.5 V, upscale 5.375 V
Fault indication output	
Output type	
Transfer characteristics	
Deviation	
After calibration	Pt100: ± (0.06 % of measurement value in K + 0.1 K (4-wire connection)) thermocouple: ± (0.05 % of measurement value in °C + 1 K (1.2 K for types R and S)) , includes ± 0.8 K fault of the cold junction compensation (CJC) mV: ± 50 µV potentiometer: ± 0.05 % of full scale, (excludes faults due to lead resistance) output: 1 to 5 V output: ± 4 mV from 0 to 103.1 % of span; 0 to 5 V output: ± 4 mV from 0.3 to 102.5 % of span
Influence of ambient temperature	Pt100: ± (0.0015 % of measurement value in K + 0.0075 % of span)/K ΔT _{amb} ¹⁾ thermocouple: ± (0.02 K + 0.005 % of measurement value in °C + 0.0075 % of span)/K ΔT _{amb} ¹⁾ , influence of cold junction compensation (CJC) included: mV: ± (0.01 % of measurement value + 0.0075 % of span)/K ΔT _{amb} ¹⁾ potentiometer: ± 0.0075 % of span/K ΔT _{amb} ¹⁾ ¹⁾ ΔT _{amb} = ambient temperature change referenced to 23 °C (296 K)
Influence of supply voltage	< 0.01 % of span
Reaction time	worst case value (sensor breakage and/or sensor short circuit detection enabled) mV: 1 s, thermocouples with CJC: 1.1 s, thermocouples with fixed reference temperature: 1.1 s, 3- or 4-wire RTD: 920 ms, 2-wire RTD: 800 ms, Potentiometer: 2.05 s
Galvanic isolation	
Output/supply, programming input	functional insulation, rated insulation voltage 50 V AC There is no electrical isolation between the programming input and the supply. The programming cable provides galvanic isolation so that ground loops are avoided.
Indicators/settings	
Display elements	LEDs
Configuration	via PACTware
Labeling	space for labeling at the front
Directive conformity	
Electromagnetic compatibility	
Directive 2014/30/EU	EN 61326-1:2013 (industrial locations)
Conformity	
Electromagnetic compatibility	NE 21:2006
Degree of protection	IEC 60529:2001

Release date: 2023-01-03 Date of issue: 2023-01-03 Filename: 248765_eng.pdf

Refer to "General Notes Relating to Pepperl+Fuchs Product Information".

Technical Data







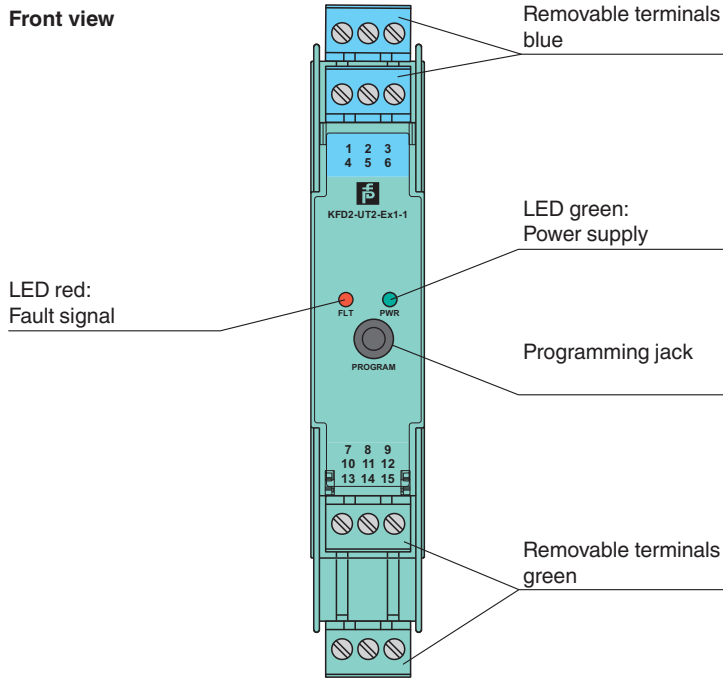

Protection against electrical shock	UL 61010-1:2004	
Ambient conditions		
Ambient temperature	-20 ... 60 °C (-4 ... 140 °F)	
Mechanical specifications		
Degree of protection	IP20	
Connection	screw terminals	
Mass	approx. 130 g	
Dimensions	20 x 119 x 115 mm (0.8 x 4.7 x 4.5 inch) (W x H x D) , housing type B2	
Mounting	on 35 mm DIN mounting rail acc. to EN 60715:2001	
Data for application in connection with hazardous areas		
EU-type examination certificate	CESI 04 ATEX 143	
Marking	Ⓜ II (1)G [Ex ia Ga] IIC Ⓜ II (1)D [Ex ia Da] IIIC Ⓜ I (M1) [Ex ia Ma] I	
Input	Ex ia	
Inputs	terminals 1, 2, 3, 4	
Voltage U_o	9 V	
Current I_o	22 mA	
Power P_o	50 mW	
Analog outputs, power supply, collective error		
Maximum safe voltage	U_m	250 V (Attention! This is not the rated voltage.)
Interface		
Maximum safe voltage	U_m	250 V (Attention! The rated voltage is lower.), RS 232
Certificate		
Marking	Ⓜ II 3G Ex nA II T4	
Galvanic isolation		
Input/Other circuits	safe electrical isolation acc. to IEC/EN 60079-11, voltage peak value 375 V	
Directive conformity		
Directive 2014/34/EU	EN 60079-0:2012+A11:2013 , EN 60079-11:2012 , EN 60079-15:2010 , EN 50303:2000	
International approvals		
UL approval		
Control drawing	116-0410	
CSA approval		
Control drawing	116-0314 (cCSAus) 116-0347	
IECEx approval		
IECEx certificate	IECEx TUN 07.0003 IECEx CML 16.0126X	
IECEx marking	[Ex ia Ga] IIC , [Ex ia Da] IIIC , [Ex ia Ma] I Ex nA IIC T4 Gc	
General information		
Supplementary information	Observe the certificates, declarations of conformity, instruction manuals, and manuals where applicable. For information see www.pepperl-fuchs.com .	

Release date: 2023-01-03 Date of issue: 2023-01-03 Filename: 248765_eng.pdf

Assembly



Matching System Components



	DTM Interface Technology	Device type manager (DTM) for interface technology
	PACTware 5.0	FDT Framework
	K-ADP-USB	Programming adapter with USB interface
	KFD2-EB2	Power Feed Module
	UPR-03	Universal Power Rail with end caps and cover, 3 conductors, length: 2 m
	UPR-03-M	Universal Power Rail with end caps and cover, 3 conductors, length: 1,6 m
	UPR-03-S	Universal Power Rail with end caps and cover, 3 conductors, length: 0.8 m
	K-DUCT-BU	Profile rail, wiring comb field side, blue
	K-DUCT-BU-UPR-03	Profile rail with UPR-03- * insert, 3 conductors, wiring comb field side, blue

Accessories

	K-CJC-BU	Terminal block for cold junction compensation, 3-pin screw terminal, blue
---	-----------------	---

Release date: 2023-01-03 Date of issue: 2023-01-03 Filename: 248765_eng.pdf

Accessories

	KF-ST-5GN	Terminal block for KF modules, 3-pin screw terminal, green
	KF-ST-5BU	Terminal block for KF modules, 3-pin screw terminal, blue
	KF-CP	Red coding pins, packaging unit: 20 x 6

Release date: 2023-01-03 Date of issue: 2023-01-03 Filename: 248765_eng.pdf

Refer to "General Notes Relating to Pepperl+Fuchs Product Information".

Pepperl+Fuchs Group
www.pepperl-fuchs.com

USA: +1 330 486 0002
pa-info@us.pepperl-fuchs.com

Germany: +49 621 776 2222
pa-info@de.pepperl-fuchs.com

Singapore: +65 6779 9091
pa-info@sg.pepperl-fuchs.com