



Temperature Converter with Trip Values

KFU8-GUT-1.D

- 1-channel signal conditioner
- Universal usage at different power supplies
- Thermocouple, RTD, potentiometer or voltage input
- Redundant TC input
- Current output 0/4 mA ... 20 mA
- 2 relay contact outputs
- Configurable by PACTware or keypad
- Line fault (LFD) and sensor burnout detection
- Up to SIL 2 acc. to IEC/EN 61508 / IEC/EN 61511

CE SIL2

Function

This signal conditioner provides the galvanic isolation between field circuits and control circuits. The device converts the signal of a resistance thermometer, thermocouple, potentiometer, or voltage source to a proportional output current. It also provides a relay trip value. The removable terminal block K-CJC-** is available as an accessory for internal cold junction compensation of thermocouples. A fault is signaled by LEDs acc. to NAMUR NE44. The device is easily configured by the use of the PACTware configuration software. For additional information, refer to the manual and www.pepperl-fuchs.com.

Connection

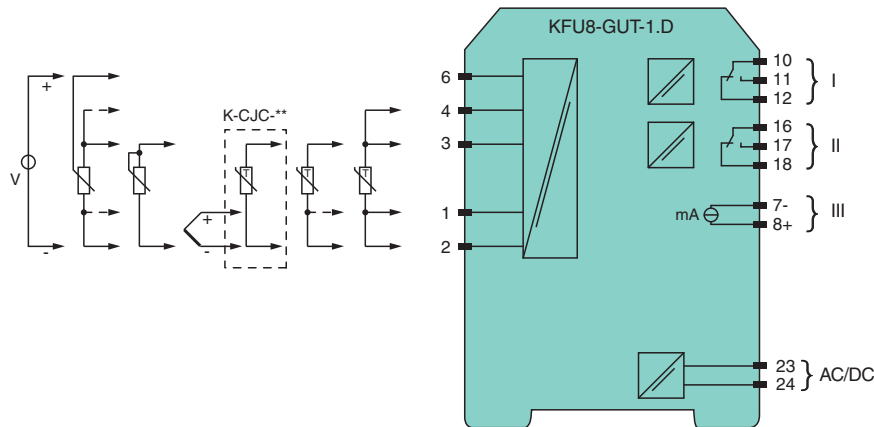

Technical Data

General specifications

Signal type Analog input

Functional safety related parameters

Safety Integrity Level (SIL) SIL 2

Supply

Connection terminals 23, 24

Rated voltage U_r 20 ... 90 V DC / 48 ... 253 V AC

Power dissipation/power consumption ≤ 2 W ; 2.5 VA / 2.2 W ; 3 VA

Interface

Release date: 2023-02-14 Date of issue: 2023-02-14 Filename: 231226_eng.pdf

Refer to "General Notes Relating to Pepperl+Fuchs Product Information".

Pepperl+Fuchs Group
www.pepperl-fuchs.com

USA: +1 330 486 0002
pa-info@us.pepperl-fuchs.com

Germany: +49 621 776 2222
pa-info@de.pepperl-fuchs.com

Singapore: +65 6779 9091
pa-info@sg.pepperl-fuchs.com

PEPPERL+FUCHS

Technical Data

Programming interface	programming socket
Input	
Connection side	field side
Connection	terminals 1, 2, 3, 4, 6
RTD	
	Pt100, Pt500, Pt1000, Ni100, Ni1000
Measuring current	approx. 400 μ A
Types of measuring	2-, 3-, 4-wire technology
Lead resistance	max. 50 Ω
Measurement loop monitoring	sensor breakage, sensor short-circuit
Thermocouples	
	type B, E, J, K, L, N, R, S, T (IEC 584-1: 1995)
Cold junction compensation	external and internal
Measurement loop monitoring	sensor breakage
Potentiometer	
	0.8 ... 20 k Ω
Types of measuring	2-, 3-, 5-wire technology
Voltage	0 ... 10 V , 2 ... 10 V , 0 ... 1 V , -100 ... 100 mV
Open loop voltage	max. 5 V with resistance measuring sensor
Input resistance	\geq 250 k Ω (0 ... 10 V) min. 1 M Ω (0 ... 1 V, -100 ... 100 mV)
Output	
Connection side	control side
Connection	output I: terminals 10, 11, 12 output II: terminals 16, 17, 18 output III: terminals 8+, 7-
Output I, II	
	relay
Contact loading	250 V AC / 2 A / $\cos \phi \geq 0.7$; 40 DC / 2 A
Mechanical life	5 x 10 ⁷ switching cycles
Energized/De-energized delay	approx. 20 ms / approx. 20 ms
Output III	
	Analog current output
Current range	0 ... 20 mA or 4 ... 20 mA
Open loop voltage	max. 24 V DC
Load	max. 650 Ω
Fault signal	downscale I \leq 3.6 mA, upscale I \geq 21 mA (acc. NAMUR NE43)
Transfer characteristics	
Deviation	
Temperature effect	Input: 0.005 %/K (50 ppm) of span ; current output: 0.005 %/K (50 ppm) of span
RTD	
	max. 0.2 % of span
Thermocouples	
	max. 10 μ V deviation of CJC: \pm 0.8 K
Voltage	
	0.1 % of span
Potentiometer	
	0.1 % of span when $<$ 5 k Ω 0.5 % of span when $>$ 5 k Ω
Current output	max. 20 μ A
Sampling rate	approx. 700 ms
Galvanic isolation	
Input/Other circuits	reinforced insulation according to IEC/EN 61010-1, rated insulation voltage 300 V _{eff}
Output I, II against eachother	reinforced insulation according to IEC/EN 61010-1, rated insulation voltage 300 V _{eff}
Output I, II/other circuits	reinforced insulation according to IEC/EN 61010-1, rated insulation voltage 300 V _{eff}
Output III/power supply	reinforced insulation according to IEC/EN 61010-1, rated insulation voltage 300 V _{eff}
Interface/power supply	reinforced insulation according to IEC/EN 61010-1, rated insulation voltage 300 V _{eff}
Indicators/settings	
Display elements	LEDs , display
Control elements	Control panel
Configuration	via operating buttons via PACTware
Labeling	space for labeling at the front

Release date: 2023-02-14 Date of issue: 2023-02-14 Filename: 231226_eng.pdf

Refer to "General Notes Relating to Pepperl+Fuchs Product Information".

 Pepperl+Fuchs Group
www.pepperl-fuchs.com

 USA: +1 330 486 0002
pa-info@us.pepperl-fuchs.com

 Germany: +49 621 776 2222
pa-info@de.pepperl-fuchs.com

 Singapore: +65 6779 9091
pa-info@sg.pepperl-fuchs.com

 **PEPPERL+FUCHS**

Technical Data

Directive conformity	
Electromagnetic compatibility	
Directive 2014/30/EU	EN 61326-1:2013 (industrial locations)
Low voltage	
Directive 2014/35/EU	EN 61010-1:2010
Conformity	
Electromagnetic compatibility	NE 21:2007
Degree of protection	IEC 60529:2001
Ambient conditions	
Ambient temperature	-20 ... 60 °C (-4 ... 140 °F)
Mechanical specifications	
Degree of protection	IP20
Connection	screw terminals
Mass	300 g
Dimensions	40 x 119 x 115 mm (1.6 x 4.7 x 4.5 inch) (W x H x D) , housing type C2
Mounting	on 35 mm DIN mounting rail acc. to EN 60715:2001
General information	
Supplementary information	Observe the certificates, declarations of conformity, instruction manuals, and manuals where applicable. For information see www.pepperl-fuchs.com .

Assembly

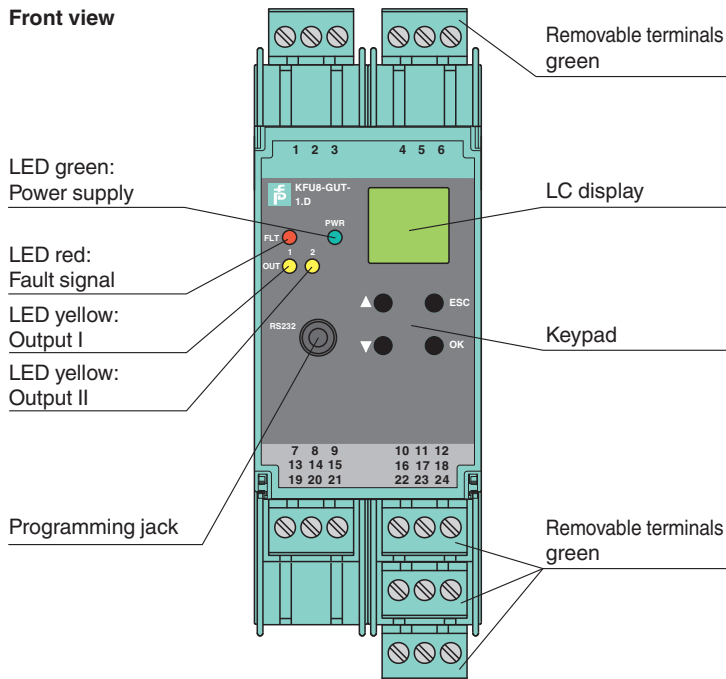



Release date: 2023-02-14 Date of issue: 2023-02-14 Filename: 231226_eng.pdf

Matching System Components





	DTM Interface Technology	Device type manager (DTM) for interface technology
	PACTware 5.0	FDT Framework

Refer to "General Notes Relating to Pepperl+Fuchs Product Information".

Matching System Components

	K-ADP-USB	Programming adapter with USB interface
	K-DUCT-GY	Profile rail, wiring comb field side, gray

Accessories

	K-250R	Measuring resistor
	K-500R0%1	Measuring resistor
	K-CJC-BK	Terminal block for cold junction compensation, 3-pin screw terminal, black
	KF-ST-5GN	Terminal block for KF modules, 3-pin screw terminal, green
	KF-CP	Red coding pins, packaging unit: 20 x 6

Application

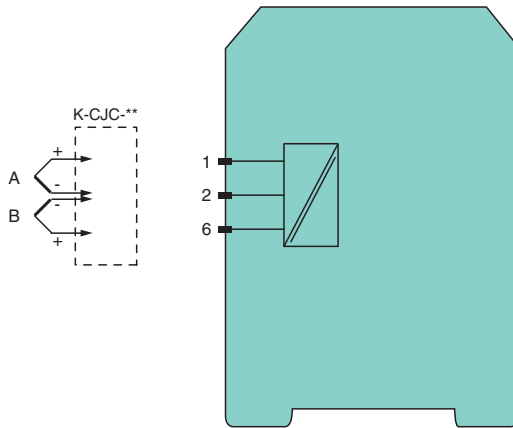

Redundant thermocouple

For higher availability it is possible to connect a second redundant thermocouple (B) of the same type to the temperature converter. The cold junction temperature is taken from the connected terminal block.

If the deviation of the both thermocouples (A and B) exceed the selected tolerance, an error will occur. If a lead breakage of one thermocouple (e. g. A) has been detected, an error message occurs and the value of the second thermocouple (B) will be taken for further calculation.

Release date: 2023-02-14 Date of issue: 2023-02-14 Filename: 231226_eng.pdf