

Frequency Converter with Direction and Synchronization Monitor

KFU8-UFT-2.D.FA

- 2-channel signal conditioner
- Universal usage at different power supplies
- Dry contact or NAMUR inputs
- Input frequency 1 mHz ... 1 kHz
- Current output 0/4 mA ... 20 mA
- Relay contact and transistor output
- Start-up override
- Configurable by PACTware or keypad
- Line fault detection (LFD)



Function

This signal conditioner analyzes 2 digital signals (NAMUR sensor/mechanical contact) and functions as a rotation direction indicator, slip monitor, frequency monitor or synchronization monitor. Each proximity sensor or switch controls a passive transistor output. The 2 relay outputs indicate if the input signal is above or below the trip value or the rotational direction. The analog output can be programmed to be proportional to the input frequency or slip differential. The unit is easily programmed by the use of a keypad located on the front of the unit or with the PACTware™ configuration software. Line fault detection of the field current is indicated by a red LED. For additional information, refer to the manual and www.pepperl-fuchs.com.

Connection

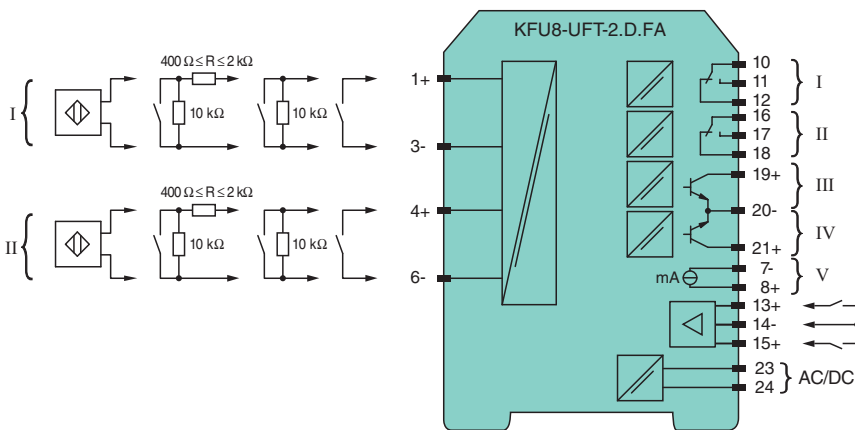

Technical Data

General specifications

Signal type	Digital Input		
Supply			
Connection	terminals 23, 24		
Rated voltage	U_r	20 ... 90 V DC / 48 ... 253 V AC	50 ... 60 Hz
Rated current	I_r	approx. 130 mA	
Power dissipation	2.2 W / 3.5 VA		
Power consumption	2.5 W / 4 VA		

Release date: 2021-12-20 Date of issue: 2021-12-20 Filename: 192334_eng.pdf

Refer to "General Notes Relating to Pepperl+Fuchs Product Information".

Pepperl+Fuchs Group
www.pepperl-fuchs.com

USA: +1 330 486 0002
pa-info@us.pepperl-fuchs.com

Germany: +49 621 776 2222
pa-info@de.pepperl-fuchs.com

Singapore: +65 6779 9091
pa-info@sg.pepperl-fuchs.com

PEPPERL+FUCHS

Technical Data

Interface	
Programming interface	programming socket
Input	
Connection side	field side
Connection	input I: terminals 1+, 3- input II: terminals 4+, 6- input III: terminals 13+, 14- (control input 1) input IV: terminals 15+, 14- (control input 2)
Input I, II	2-wire sensor, sensor acc. to EN 60947-5-6 (NAMUR) or mechanical contact
Open circuit voltage/short-circuit current	8.2 V / 10 mA
Switching point/switching hysteresis	logic 1: > 2.5 mA ; logic 0: < 1.9 mA
Pulse duration	min. 250 μ s , overlap on direction of rotation signal: \geq 125 μ s
Input frequency	rotation direction monitoring 0.001 ... 1000 Hz slip monitoring 10 ... 1000 Hz
Line fault detection	breakage $I \leq 0.15$ mA; short-circuit $I > 4$ mA
Input III, IV	
Active/Passive	$I > 4$ mA (for min. 100 ms) / $I < 1.5$ mA
Open circuit voltage/short-circuit current	18 V / 5 mA
Output	
Connection side	control side
Connection	output I: terminals 10, 11, 12 output II: terminals 16, 17, 18 output III: terminals 19+, 20- output IV: terminals 21+, 20- output V: terminals 7-, 8+
Output I, II	signal, relay
Contact loading	250 V AC / 2 A / $\cos \phi \geq 0.7$; 40 DC / 2 A
Mechanical life	5×10^7 switching cycles
Energized/De-energized delay	approx. 20 ms / approx. 20 ms
Output III and IV	signal , electronic output, passive
Contact loading	40 V DC
Signal level	1-signal: (L+) -2.5 V (50 mA, short-circuit/overload proof) 0-signal: blocked output (off-state current ≤ 10 μ A)
Output V	analog
Current range	0 ... 20 mA or 4 ... 20 mA
Open loop voltage	max. 24 V DC
Load	max. 650 Ω
Fault signal	downscale $I \leq 3.6$ mA, upscale $I \geq 21.5$ mA (acc. NAMUR NE43)
Programming interface	
Connection	programming socket
Interface	RS 232
Transfer characteristics	
Input I and II	
Measurement range	0.001 ... 1000 Hz
Resolution	slip monitoring: 1% frequency measurement: 0,1% of measured value; but >0.001Hz
Accuracy	slip monitoring: 1% frequency measurement: 0.5% of measured value; but >0.001Hz
Measuring time	frequency measurement: < 100 ms
Influence of ambient temperature	0.003 %/K (30 ppm)
Output I, II	
Response delay	≤ 200 ms
Output V	
Resolution	< 10 μ A
Accuracy	< 30 μ A
Influence of ambient temperature	0.005 %/K (50 ppm)
Galvanic isolation	
Input I, II/other circuits	reinforced insulation according to IEC/EN 61010-1, rated insulation voltage 300 V _{eff}
Input III, IV/power supply	reinforced insulation according to IEC/EN 61010-1, rated insulation voltage 300 V _{eff}

Release date: 2021-12-20 Date of issue: 2021-12-20 Filename: 192334_eng.pdf

Refer to "General Notes Relating to Pepperl+Fuchs Product Information".

Pepperl+Fuchs Group
www.pepperl-fuchs.comUSA: +1 330 486 0002
pa-info@us.pepperl-fuchs.comGermany: +49 621 776 2222
pa-info@de.pepperl-fuchs.comSingapore: +65 6779 9091
pa-info@sg.pepperl-fuchs.com

PEPPERL+FUCHS



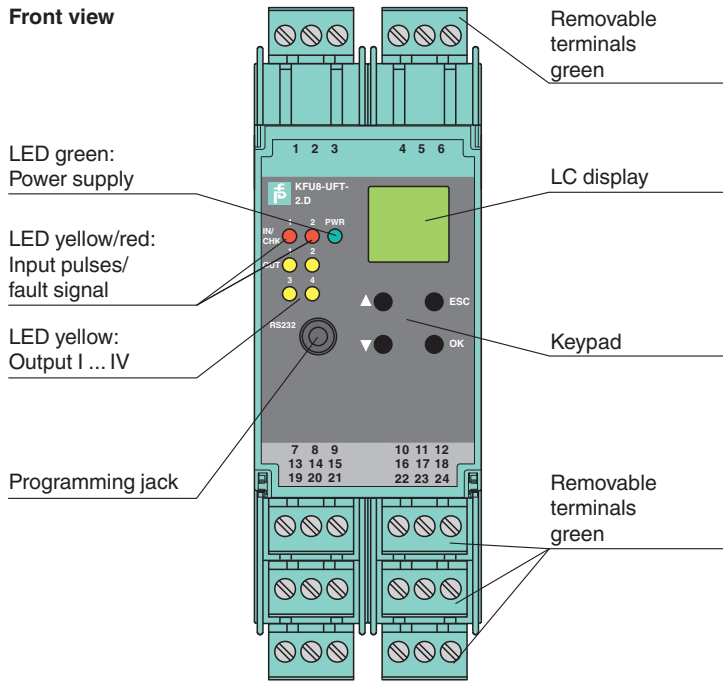

Technical Data

Output I, II/other circuits		reinforced insulation according to IEC/EN 61010-1, rated insulation voltage 300 V _{eff}
Mutual output I, II, III		reinforced insulation according to IEC/EN 61010-1, rated insulation voltage 300 V _{eff}
Mutual output I, II, IV		reinforced insulation according to IEC/EN 61010-1, rated insulation voltage 300 V _{eff}
Output III, IV/power supply		reinforced insulation according to IEC/EN 61010-1, rated insulation voltage 300 V _{eff}
Output III, IV/input III, IV		basic insulation according to IEC/EN 61010-1, rated insulation voltage 50 V _{eff}
Output III, IV/V		basic insulation according to IEC/EN 61010-1, rated insulation voltage 50 V _{eff}
Output V/power supply		reinforced insulation according to IEC/EN 61010-1, rated insulation voltage 300 V _{eff}
Interface/power supply		reinforced insulation according to IEC/EN 61010-1, rated insulation voltage 300 V _{eff}
Interface/output III, IV		basic insulation according to IEC/EN 61010-1, rated insulation voltage 50 V _{eff}
Indicators/settings		
Display elements		LEDs , display
Control elements		Control panel
Configuration		via operating buttons via PACTware
Labeling		space for labeling at the front
Directive conformity		
Electromagnetic compatibility		
Directive 2014/30/EU		EN 61326-1:2006
Low voltage		
Directive 2014/35/EU		EN 61010-1:2010
Conformity		
Electromagnetic compatibility		NE 21:2006
Degree of protection		IEC 60529:2001
Input		EN 60947-5-6:2000
Ambient conditions		
Ambient temperature		-20 ... 60 °C (-4 ... 140 °F)
Mechanical specifications		
Degree of protection		IP20
Connection		screw terminals
Mass		300 g
Dimensions		40 x 119 x 115 mm (1.6 x 4.7 x 4.5 inch) (W x H x D) , housing type C2
Mounting		on 35 mm DIN mounting rail acc. to EN 60715:2001
General information		
Supplementary information		Observe the certificates, declarations of conformity, instruction manuals, and manuals where applicable. For information see www.pepperl-fuchs.com .





Assembly



Matching System Components

	DTM Interface Technology	Device type manager (DTM) for interface technology
	PACTware 5.X	FDT Framework
	K-ADP-USB	Programming adapter with USB interface
	K-DUCT-GY	Profile rail, wiring comb field side, gray

Accessories

	VAZ-CHAIN-BU/BN70MM/1,0-25	25-point wiring link for control cabinet modules with screw terminals
	K-250R	Measuring resistor
	K-500R0%1	Measuring resistor
	KF-ST-5GN	Terminal block for KF modules, 3-pin screw terminal, green
	KF-CP	Red coding pins, packaging unit: 20 x 6

Release date: 2021-12-20 Date of issue: 2021-12-20 Filename: 192334_eng.pdf

Refer to "General Notes Relating to Pepperl+Fuchs Product Information".

Pepperl+Fuchs Group
www.pepperl-fuchs.com

USA: +1 330 486 0002
pa-info@us.pepperl-fuchs.com

Germany: +49 621 776 2222
pa-info@de.pepperl-fuchs.com

Singapore: +65 6779 9091
pa-info@sg.pepperl-fuchs.com

 **PEPPERL+FUCHS**

Operation

The device processes two input frequencies up to a max. of 1 kHz. The following functions are provided by the device:

- Frequency measurement with freely adjustable trip value monitoring for high and low alarm as well as for frequency-current-conversion (0/4 mA ... 20 mA)
- Slip monitoring: The slip is calculated from the two input frequencies at channel I and II. If the freely parameterisable trip value is exceeded, the respective output switches.
- Rotation direction signalling: The rotation direction is evaluated from the two input signals with the same frequency and a phase shift of 90°. The corresponding outputs switch according to the direction of rotation.
- The frequency monitoring can be used in combination with rotation direction signalling or slip monitoring.
- Synchronisation monitor: The synchronisation monitor compares the pulse counts of the two inputs. If the measured difference in the pulses is greater than the programmed value the corresponding outputs are switching.

The two electronic outputs serve to repeat the input signals.

Characteristic Curve

Maximum Switching Power of Output Contacts

