



Zener Barrier

Z828.H.F

- 1-channel
- DC version, negative polarity
- Working voltage 26.5 V at 10 μ A
- Series resistance max. 273 Ω
- Fuse rating 50 mA
- DIN rail mountable
- High power version
- Replaceable back-up fuse



Function

The Zener Barrier prevents the transfer of unacceptably high energy from the safe area into the hazardous area. The zener diodes in the Zener Barrier are connected in the reverse direction. The breakdown voltage of the diodes is not exceeded in normal operation. If this voltage is exceeded, due to a fault in the safe area, the diodes start to conduct, causing the fuse to blow. The Zener Barrier has a negative polarity, i. e. the cathodes of the zener diodes are grounded. Additionally this Zener Barrier is equipped with a replaceable fuse. This high power version has a smaller serial resistance and therefore provides higher voltage to the field device.

Connection

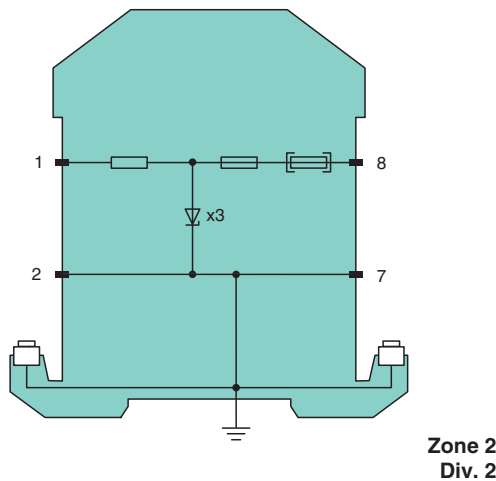
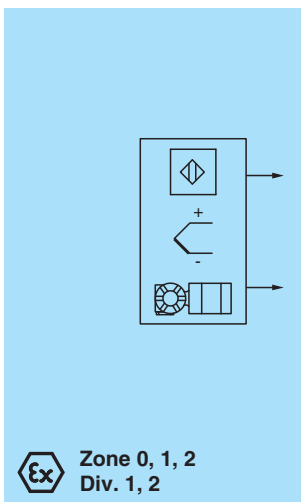

Technical Data

General specifications	
Type	DC version, negative polarity
Electrical specifications	
Nominal resistance	240 Ω
Series resistance	max. 273 Ω
Fuse rating	50 mA
Hazardous area connection	
Connection	terminals 1, 2
Safe area connection	
Connection	terminals 7, 8
Working voltage	

Release date: 2023-04-18 Date of issue: 2023-04-18 Filename: 072204_eng.pdf

Refer to "General Notes Relating to Pepperl+Fuchs Product Information".

Pepperl+Fuchs Group
www.pepperl-fuchs.com

USA: +1 330 486 0002
pa-info@us.pepperl-fuchs.com

Germany: +49 621 776 2222
pa-info@de.pepperl-fuchs.com

Singapore: +65 6779 9091
pa-info@sg.pepperl-fuchs.com

PEPPERL+FUCHS

Technical Data







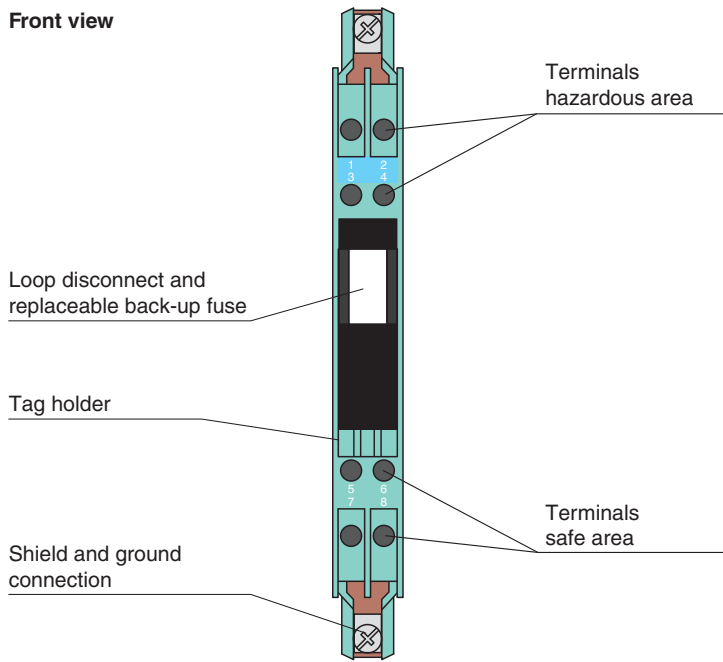



Supply loop	max. 27 V		
Measurement loop	max. 26.5 V at 10 μ A		
Conformity			
Degree of protection	IEC 60529		
Ambient conditions			
Ambient temperature	-20 ... 60 °C (-4 ... 140 °F)		
Storage temperature	-25 ... 70 °C (-13 ... 158 °F)		
Relative humidity	max. 75 % , without condensation		
Mechanical specifications			
Degree of protection	IP20		
Connection	screw terminals		
Core cross section	max. 2 x 2.5 mm ²		
Mass	approx. 150 g		
Dimensions	12.5 x 115 x 116 mm (0.5 x 4.5 x 4.6 inch) (W x H x D)		
Construction type	modular terminal housing , see system description		
Mounting	on 35 mm DIN mounting rail acc. to EN 60715:2001		
Data for application in connection with hazardous areas			
EU-type examination certificate	BAS 00 ATEX 7096		
Marking	⊕ II (1)G [Ex ia Ga] IIC , ⊕ II (1)D [Ex ia Da] IIIC , ⊕ I (M1) [Ex ia Ma] I		
Voltage	U _o	28 V	
Current	I _o	120 mA	
Power	P _o	830 mW	
Supply			
Maximum safe voltage	U _m	250 V	
Series resistance	min. 235 Ω		
Certificate	TÜV 99 ATEX 1484 X		
Marking	⊕ II 3G Ex nA IIC T4 Gc		
Directive conformity			
Directive 2014/34/EU	EN IEC 60079-0:2018+AC:2020 , EN 60079-11:2012 , EN 60079-15:2010		
International approvals			
FM approval			
Control drawing	116-0118		
UL approval			
Control drawing	116-0355 (cULus)		
IECEx approval			
IECEx certificate	IECEx BAS 18.0033		
IECEx marking	[Ex ia Ga] IIC , [Ex ia Da] IIIC , [Ex ia Ma] I		
General information			
Supplementary information	Observe the certificates, declarations of conformity, instruction manuals, and manuals where applicable. For information see www.pepperl-fuchs.com .		

Assembly

Front view



Matching System Components

	ZH-ES/LB	Insertion Strip
	ZH-Z.AB/NS	Mounting block for DIN mounting rail
	ZH-Z.AB/SS	Mounting block for grounding rail
	ZH-Z.AK16	Connection terminal for grounding rail
	ZH-Z.AR.125	Spacing Roller
	ZH-Z.BT	Label Carrier
	ZH-Z.ES	Single Socket
	ZH-Z.LL	Ground Rail Feed
	ZH-Z.NLS-Cu3/10	Grounding Rail
	USLKG5	Terminal block for equipotential bonding

Release date: 2023-04-18 Date of issue: 2023-04-18 Filename: 072204_eng.pdf

Refer to "General Notes Relating to Pepperl+Fuchs Product Information".