

Potentiometer Converter

KFD2-PT2-Ex1-1

- 1-channel isolated barrier
- 24 V DC supply (Power Rail)
- Potentiometer input
- Voltage output 0 V ... 5 V
- Lead resistance compensation adjustment
- Accuracy 0.05 %
- Up to SIL 2 acc. to IEC/EN 61508



Function

This isolated barrier is used for intrinsic safety applications. It provides the source voltage to a potentiometer and transfers its wiper position from hazardous areas to safe areas. It then converts the signal to a 0 V ... 5 V voltage output (consistent with 0 mA ... 20mA current output, see for example KFD2-PT2-Ex1-4).

The unit can be used in a 3-, 4-, or 5-wire configuration depending on the required measurement accuracy. Terminals 2 and 5 are used as the sense line for the potentiometer lead resistance compensation in a 5-wire configuration.

The barrier's potentiometer can be used to compensate for lead resistance up to 5 % of the hazardous area potentiometer value.

Connection

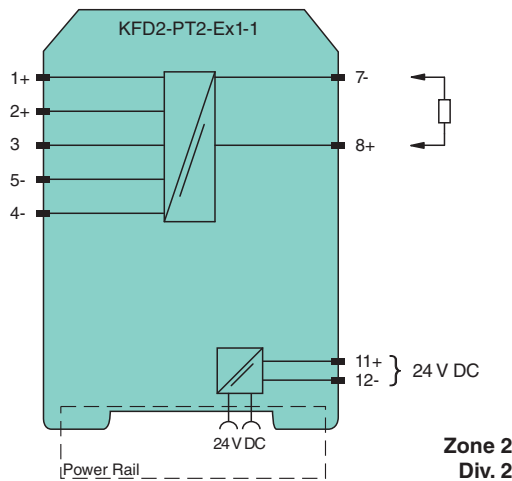
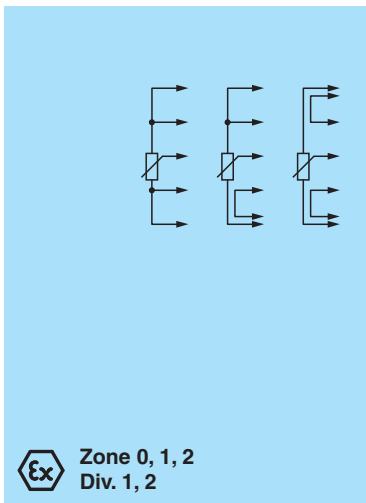

Technical Data

General specifications

Signal type Analog input

Functional safety related parameters

Safety Integrity Level (SIL) SIL 2

Supply

Connection Power Rail or terminals 11+, 12-

Rated voltage U_r 20 ... 35 V DC

Ripple within the supply tolerance

Power dissipation 0.5 W

Power consumption 0.6 W

Input

Release date: 2023-04-06 Date of issue: 2023-04-06 Filename: 072019_eng.pdf

Refer to "General Notes Relating to Pepperl+Fuchs Product Information".

Pepperl+Fuchs Group
www.pepperl-fuchs.com

USA: +1 330 486 0002
pa-info@us.pepperl-fuchs.com

Germany: +49 621 776 2222
pa-info@de.pepperl-fuchs.com

Singapore: +65 6779 9091
pa-info@sg.pepperl-fuchs.com

PF PEPPERL+FUCHS

Technical Data

Connection side	field side	
Connection	terminals 4-, 5-, 3+, 2+, 1+	
Potentiometer		
Types of measuring	3-, 4-, 5-wire technology	
Nominal resistance	800 Ω to 100 k Ω	
Supply voltage	approx. 4.7 V	
Lead resistance	5 % of the potentiometer resistance (adjustable)	
Output		
Connection side	control side	
Connection	terminals 7-, 8+	
Voltage output	0 ... 5 V	
Output resistance	max. 30 Ω	
Transfer characteristics		
Accuracy	0.05 %	
Deviation		
Linearity	$\leq \pm 5$ mV	
Influence of ambient temperature	≤ 0.5 mV/K	
Rise time	10 to 90 % ≤ 8 ms; 10 to 90 % within 1 % of span ≤ 25 ms	
Galvanic isolation		
Output/power supply	functional insulation, rated insulation voltage 50 V AC	
Indicators/settings		
Control elements	potentiometer	
Configuration	via potentiometer	
Directive conformity		
Electromagnetic compatibility		
Directive 2014/30/EU	EN 61326-1:2013 (industrial locations)	
Conformity		
Electromagnetic compatibility	NE 21:2006	
Degree of protection	IEC 60529:2001	
Protection against electrical shock	UL 61010-1	
Ambient conditions		
Ambient temperature	-20 ... 60 $^{\circ}$ C (-4 ... 140 $^{\circ}$ F)	
Mechanical specifications		
Degree of protection	IP20	
Connection	screw terminals	
Mass	approx. 120 g	
Dimensions	20 x 107 x 115 mm (0.8 x 4.2 x 4.5 inch) (W x H x D) , housing type B1	
Mounting	on 35 mm DIN mounting rail acc. to EN 60715:2001	
Data for application in connection with hazardous areas		
EU-type examination certificate	BAS 00 ATEX 7171	
Marking	Ⓔ II (1)G [Ex ia Ga] IIC , Ⓔ II (1)D [Ex ia Da] IIIC , Ⓔ I (M1) [Ex ia Ma] I	
Voltage	U _o	10.4 V DC
Current	I _o	31.4 mA
Power	P _o	82 mW
Supply		
Maximum safe voltage	U _m	250 V (Attention! The rated voltage can be lower.)
Output		
Maximum safe voltage	U _m	250 V (Attention! The rated voltage can be lower.)
Certificate		
Marking	Ⓔ II 3G Ex nA II T4	
Galvanic isolation		
Input/Output	safe electrical isolation acc. to IEC/EN 60079-11, voltage peak value 375 V	
Input/power supply	safe electrical isolation acc. to IEC/EN 60079-11, voltage peak value 375 V	

Release date: 2023-04-06 Date of issue: 2023-04-06 Filename: 072019_eng.pdf

Refer to "General Notes Relating to Pepperl+Fuchs Product Information".

Pepperl+Fuchs Group
www.pepperl-fuchs.comUSA: +1 330 486 0002
pa-info@us.pepperl-fuchs.comGermany: +49 621 776 2222
pa-info@de.pepperl-fuchs.comSingapore: +65 6779 9091
pa-info@sg.pepperl-fuchs.com

PEPPERL+FUCHS

Technical Data



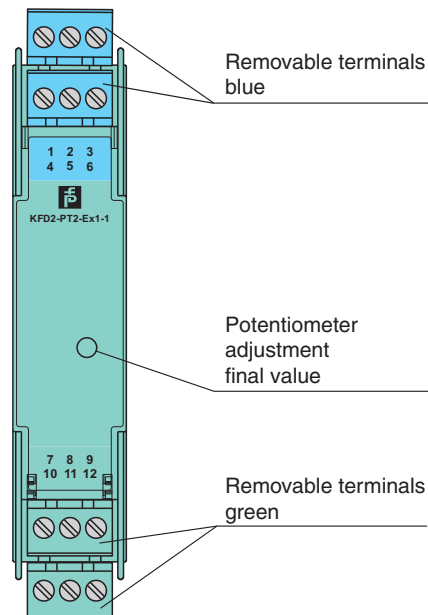

Directive conformity	
Directive 2014/34/EU	EN IEC 60079-0:2018+AC:2020 , EN 60079-11:2012 , EN 60079-15:2010
International approvals	
FM approval	
Control drawing	116-0129
UL approval	
Control drawing	116-0173 (cULus)
IECEX approval	
IECEX certificate	IECEX BAS 10.0060 IECEX BAS 10.0061X
IECEX marking	[Ex ia Ga] IIC, [Ex ia Da] IIIC, [Ex ia Ma] I Ex ec IIC T4 Gc
General information	
Supplementary information	Observe the certificates, declarations of conformity, instruction manuals, and manuals where applicable. For information see www.pepperl-fuchs.com .

Assembly

Front view



Matching System Components

	KFD2-EB2	Power Feed Module
	UPR-03	Universal Power Rail with end caps and cover, 3 conductors, length: 2 m
	UPR-03-M	Universal Power Rail with end caps and cover, 3 conductors, length: 1,6 m
	UPR-03-S	Universal Power Rail with end caps and cover, 3 conductors, length: 0.8 m

Release date: 2023-04-06 Date of issue: 2023-04-06 Filename: 072019_eng.pdf

Refer to "General Notes Relating to Pepperl+Fuchs Product Information".

Pepperl+Fuchs Group
www.pepperl-fuchs.com



USA: +1 330 486 0002
pa-info@us.pepperl-fuchs.com

Germany: +49 621 776 2222
pa-info@de.pepperl-fuchs.com



Singapore: +65 6779 9091
pa-info@sg.pepperl-fuchs.com

 **PEPPERL+FUCHS**

Matching System Components

	K-DUCT-BU	Profile rail, wiring comb field side, blue
	K-DUCT-BU-UPR-03	Profile rail with UPR-03- * insert, 3 conductors, wiring comb field side, blue

Accessories

	KF-ST-5GN	Terminal block for KF modules, 3-pin screw terminal, green
	KF-ST-5BU	Terminal block for KF modules, 3-pin screw terminal, blue
	KF-CP	Red coding pins, packaging unit: 20 x 6

Release date: 2023-04-06 Date of issue: 2023-04-06 Filename: 072019_eng.pdf

Application

Jumpers must be used on terminals 1, 2 and 4, 5 in 3-wire configurations. A jumper must be used between terminals 4 and 5 in 4-wire connections. In the 5-wire mode of operation, the potentiometer voltage is measured at terminals 2 and 5 and automatically readjusted.

The front side potentiometer can be used to compensate for lead resistances up to 5 % of the potentiometer value. During adjustment, the potentiometer is set to 100 % of its value and the output signal is adjusted to 100 % of the required value. This adjustment can be repeated setting the potentiometer to 0 %.