

Switch Amplifier

KFD2-SH-Ex1

- 1-channel isolated barrier
- 24 V DC supply (Power Rail)
- Input for approved dry contacts or SN/S1N sensors
- Relay contact output
- Fault indication output
- Line fault detection (LFD)
- Up to SIL 3 acc. to IEC/EN 61508
- Up to PL d acc. to EN/ISO 13849



SIL 3 PL d



Function

This isolated barrier is used for intrinsic safety applications. The device transfers digital signals (SN/S1N proximity sensors or approved dry contacts) from a hazardous area to a safe area. The input controls one relay contact output with 3 NO contacts (one output is in series to the both output relays for the safety function), one relay contact output with one NO contact, and one passive transistor output. Unlike an SN/S1N series proximity sensor, a mechanical contact, requires a 10 kΩ resistor to be placed across the contact in addition to a 1.5 kΩ resistor in series. Lead breakage (LB) and short circuit (SC) conditions of the control circuit are continuously monitored. During a fault condition, the fault indication output energizes and outputs I and II de-energize. For safety applications up to SIL3, output I must be used. For safety applications up to SIL2, output I and output II can be used.

Connection

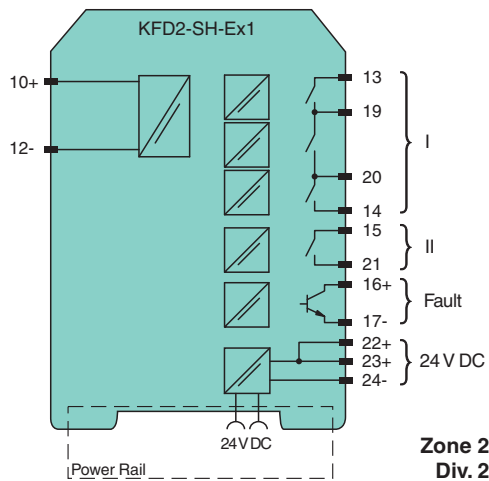
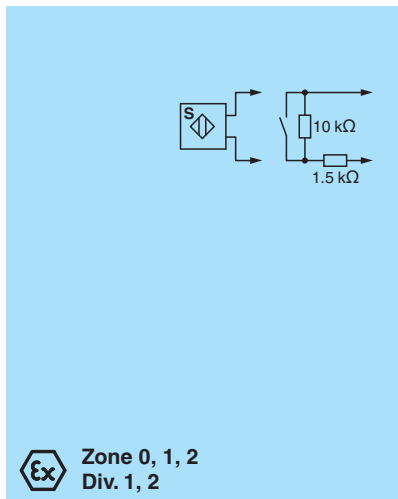

Technical Data

General specifications	
Signal type	Digital Input
Functional safety related parameters	
Safety Integrity Level (SIL)	SIL 3
Performance level (PL)	PL d
Supply	
Connection	Power Rail or terminals 22+, 23+, 24-
Rated voltage	U _r 20 ... 35 V DC
Ripple	≤ 10 %

Release date: 2022-09-19 Date of issue: 2022-09-19 Filename: 046903_eng.pdf

Refer to "General Notes Relating to Pepperl+Fuchs Product Information".

Pepperl+Fuchs Group
www.pepperl-fuchs.com

USA: +1 330 486 0002
pa-info@us.pepperl-fuchs.com

Germany: +49 621 776 2222
pa-info@de.pepperl-fuchs.com

Singapore: +65 6779 9091
pa-info@sg.pepperl-fuchs.com



Technical Data

Rated current	I_r	≤ 130 mA
Power dissipation		2.1 W
Power consumption		max. 2.3 W
Input		
Connection side		field side
Connection		terminals 10+, 12-
Open circuit voltage/short-circuit current		approx. 8.4 V DC / approx. 11.7 mA
Lead resistance		≤ 50 Ω , in hazardous area cable capacitances and inductivities are to be taken into account
Switching point		
Relay de-energized		$I < 2.1$ mA and $I > 5.9$ mA
Relay energized		2.8 mA $< I < 5.3$ mA
Response delay		≤ 1 ms
Output		
Connection side		control side
Connection		output I: terminals 13, 14 ; output II: terminals 15, 21 ; output III: terminals 16+, 17-
Output I		relay , signal
Contact loading		50 V AC/1 A/cos $\phi > 0.7$; 24 V DC/1 A resistive load
Mechanical life		50×10^6 switching cycles
Output II		relay , signal
Contact loading		50 V AC/1 A/cos $\phi > 0.7$; 24 V DC/1 A resistive load
Mechanical life		50×10^6 switching cycles
Output III		electronic output, passive , fault signal
Rated voltage		10 ... 30 V DC
Signal level		1-signal: (L+) -2.5 V (7 mA, short-circuit proof) / 0-signal: blocked output (Leakage current ≤ 10 μ A)
Transfer characteristics		
Switching frequency		5 Hz
Galvanic isolation		
Output/power supply		reinforced insulation according to IEC/EN 61010-1, rated insulation voltage 300 V _{eff}
Mutual output I, II, III		basic insulation according to IEC/EN 61010-1, rated insulation voltage 50 V _{eff}
Indicators/settings		
Display elements		LEDs
Labeling		space for labeling at the front
Directive conformity		
Electromagnetic compatibility		
Directive 2014/30/EU		EN 61326-1:2013 (industrial locations)
Machinery Directive		
Directive 2006/42/EC		EN/ISO 13849-1:2015
Conformity		
Electromagnetic compatibility		NE 21:2011
Degree of protection		IEC 60529:2001
Safety		IEC/EN 61508:2010
Ambient conditions		
Ambient temperature		-20 ... 60 °C (-4 ... 140 °F)
Mechanical specifications		
Degree of protection		IP20
Connection		screw terminals
Mass		approx. 280 g
Dimensions		40 x 107 x 115 mm (1.6 x 4.2 x 4.5 inch) (W x H x D) , housing type C1
Mounting		on 35 mm DIN mounting rail acc. to EN 60715:2001
Data for application in connection with hazardous areas		
EU-type examination certificate		PTB 00 ATEX 2042

Release date: 2022-09-19 Date of issue: 2022-09-19 Filename: 046903_eng.pdf

Technical Data

Marking		Ⓜ II (1)G [Ex ia Ga] IIC Ⓜ II (1)D [Ex ia Da] IIIC Ⓜ I (M1) [Ex ia Ma] I
Input		Ex ia
Voltage	U_o	9.56 V
Current	I_o	16.8 mA
Power	P_o	41 mW (linear characteristic)
Supply		
Maximum safe voltage	U_m	40 V AC/DC (Attention! The rated voltage can be lower.)
Output		
Maximum safe voltage	U_m	output I/output II: 253 V AC/DC (Attention! U_m is no rated voltage.) output III: 60 V AC/DC (Attention! U_m is no rated voltage.)
Certificate		TÜV 99 ATEX 1493 X
Marking		Ⓜ II 3G Ex ec nC IIC T4 Gc
Galvanic isolation		
Input/Output		safe electrical isolation acc. to IEC/EN 60079-11, voltage peak value 375 V
Input/power supply		safe electrical isolation acc. to IEC/EN 60079-11, voltage peak value 375 V
Directive conformity		
Directive 2014/34/EU		EN IEC 60079-0:2018+AC:2020 , EN 60079-7:2015+A1:2018 , EN 60079-11:2012 , EN IEC 60079-15:2019
International approvals		
FM approval		
Control drawing		116-0158
IECEx approval		
IECEx certificate		IECEx TUN 19.0013X
IECEx marking		Ex ec nC IIC T4 Gc
General information		
Supplementary information		Observe the certificates, declarations of conformity, instruction manuals, and manuals where applicable. For information see www.pepperl-fuchs.com .

Assembly

Front view

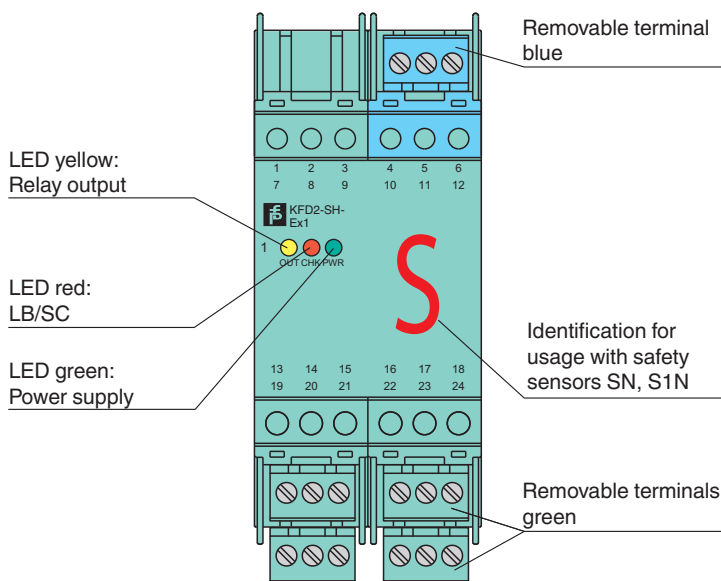

Release date: 2022-09-19 Date of issue: 2022-09-19 Filename: 046903_eng.pdf

Refer to "General Notes Relating to Pepperl+Fuchs Product Information".







Pepperl+Fuchs Group
www.pepperl-fuchs.com

USA: +1 330 486 0002
pa-info@us.pepperl-fuchs.com



Germany: +49 621 776 2222
pa-info@de.pepperl-fuchs.com

Singapore: +65 6779 9091
pa-info@sg.pepperl-fuchs.com

Matching System Components

	KFD2-EB2	Power Feed Module
	UPR-03	Universal Power Rail with end caps and cover, 3 conductors, length: 2 m
	UPR-03-M	Universal Power Rail with end caps and cover, 3 conductors, length: 1,6 m
	UPR-03-S	Universal Power Rail with end caps and cover, 3 conductors, length: 0.8 m
	K-DUCT-BU	Profile rail, wiring comb field side, blue
	K-DUCT-BU-UPR-03	Profile rail with UPR-03- * insert, 3 conductors, wiring comb field side, blue

Accessories

	KF-ST-5GN	Terminal block for KF modules, 3-pin screw terminal, green
	KF-ST-5BU	Terminal block for KF modules, 3-pin screw terminal, blue
	KF-CP	Red coding pins, packaging unit: 20 x 6

Application

The input (terminals 10, 12) may generally be operated only with **potentially free** (passive) switches.

Single channel operations up to SIL3 **must** occur via terminals 13 and 14. The center tap of the contacts (terminals 19, 20) can **also** be used if an operation is to occur a redundant branch.

If the device is used for safety operations the information in the test documents should be observed. The output III error message delivers a "1"-signal when the control circuit experiences lead breakage (LB) or a short circuit (LK).

The device has removable terminals.

Characteristic Curve

Maximal switching power of the output

